



ELECTRONIC VALVES



Original Mouse Valve Series 177 - 200



NEW! DV 2-Way Valve Series 201 - 203



EXPANDED! Proportional Valves 204 - 209



NEW! EGV High Flow Poppet Valves 212 - 213



10 & 15 mm Valves 214 - 227



Maximatic® Valve Series 228 - 238



Original Mouse Valve Series

- Industry standard for leak-free operation
- 1,000,000,000+ cycle life
- Quiet operation
- Various flow rates, mounting types and connection options
- Industries first “spider” design
- Fast response
- Low power
- Low heat rise and power



Analytical Series



Oxygen Clean



Corrosion-Resistant



ECN, ETN EVN Series



Intrinsically Safe



EM Series



ES Series



NEW! DV 2-Way Valve Series

- Flow rates to 100 l/min
- Bidirectional
- Practical, sleek design
- 1,000,000,000+ cycle life
- Low heat rise and power



Proportional Valve Series

- Direct-operated
- Low hysteresis
- Fast response
- High flow and cycle life
- Excellent linearity

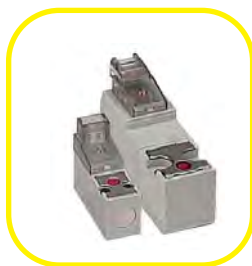

10 & 15 mm Valve Series

- 2-way or 3-way operation
- Detachable coil and connector for orientation options
- Variety of electrical circuit features
- Manifold options available

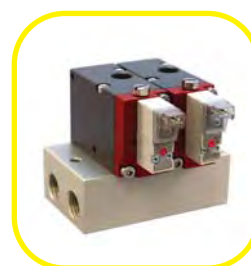

NEW! High Flow Poppet Valves

- Electronically-piloted
- Ideal for large flow, low leak applications
- Small, compact, lightweight
- Flows to 53 scfm



Maximatic® Valve Series

- General purpose, 2-way, 3- way and 4-way configurations
- Maximum Value, Maximum Performance
- Direct- and pilot-operated
- Manifold or in-line mounting
- NAMUR style



Custom Electronic Valves

With years of engineering and technical experience, Clippard continues to be a leader in manufacturing special products for a broad spectrum of industries.



ELECTRONIC MOUSE SERIES

Clippard's Unique Electronic "Mouse" Valves

Clippard's Electronic Valves are quiet and quick! Valves accept low voltage, low current signals, convert them into high pressure (100 psig) pneumatic outputs. Optional low pressure/medium flow and low pressure/high flow are available.

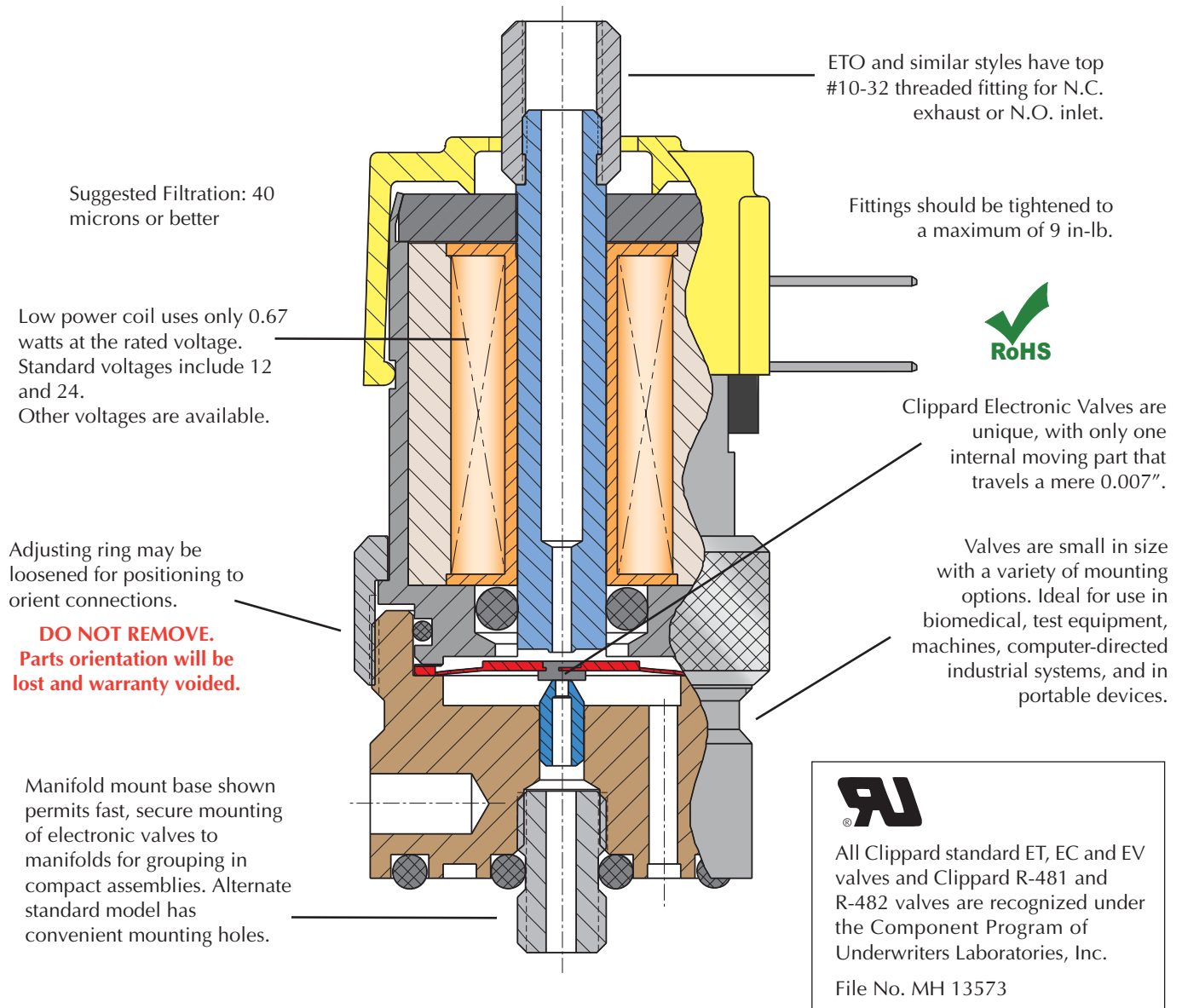

Clippard Minimatic electronic valves are precision-built 2-way or 3-way control valves, utilizing a unique, patented, valving principle. There are no sliding parts. Complete poppet travel is a mere 0.007". As a result, low power consumption and exceptionally long life are major benefits of this design.

The valves are very quiet in operation and also very cool. The valves' small size makes them well suited to a wide range of applications in biomedical, environmental test equipment, textile machines, packaging machinery, computerized industrial automation, and portable systems.

Clippard Functional Simplicity

- The design of Clippard electronic valves is a deceptively simple arrangement with a minimum of operating parts, and remarkably straight forward low power operation.
- The Clippard “spider” is the only moving part and its motion to operate the valve is a mere 0.007” travel.
- Low voltage D.C. inputs, signals from simple manual switching up to computer directed systems, move the spider in extremely fast response time . . . 5 to 10 milliseconds.
- The unit uses extremely low power (0.67 watts at the rated voltage) and is cool running. The valves are light in weight, compact in physical size and mount easily in space-saving packages.



Quick Connect

Clippard ET valves feature spade lugs for simple, quick secure low voltage connections. Wire crimp-on spade lug connectors are available separately to adapt electronic wiring where necessary. Clippard original EV type valves are available in popular voltages with 18” wire leads. The EC model utilizes a 0.025” square pin connector.



Easy Mounting

The complete line of EC, EV, ET and EW electronic valves are available with two mounting options. Standard base models have two 6-32 threaded, 7/32” deep mounting holes. Manifold models are equipped with a bottom stud, 5/32” long with #10-32 thread, which fits Clippard standard and special manifolds, accessory valves and subplates. Spanner holes in the valve body permit tightening.

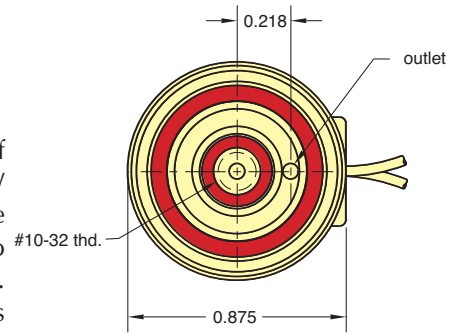

CUSTOM SOLUTIONS

If you need a product that fits your application perfectly, Clippard has the capability to design or modify one of its products to suit your exact needs. We understand that a standard catalog product may be close but not be exactly what you need. Let us know YOUR need, and we will help to find YOUR Solution!

CUSTOMer solutions



Clippard's Electronic Valves are incredibly flexible from a production standpoint. Just let us know what you need.

- Custom Voltage
- Custom Flow Rate
- Custom Max Pressure/ Vacuum

Tight Assemblies

Cartridge design is desirable for integrating valves into compact assemblies. This EVP proportional valve is calibrated to meet the customers flow range and maintain “zero” leak rate, and is incorporated into the OEM’s manifold.



Clippard Integrated Solutions

offer optimized pneumatic system design to increase performance, reduce cost, and make your job easier.





MOUSE VALVE SERIES DESCRIPTIONS



Standard Series

2- and 3-way manifold and in-line mounting. Normally-Closed and fully-ported versions.

Higher Flow 2-Way Version. The standard series also includes an option that provides higher flow for 2-way, Normally-Closed applications. Although manifold mounting is accomplished in the same fashion, the inlet is the annular port, and the outlet becomes the center port, through the convenient stud mount of the valve.

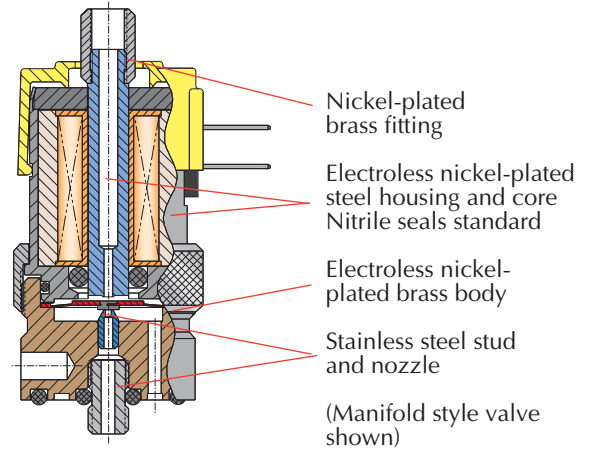

- Nickel-plated brass fitting
 - Electroless nickel-plated steel housing and core
Nitrile seals standard
 - Electroless nickel-plated brass body
 - Stainless steel stud and nozzle
- (Manifold style valve shown)



Corrosion-Resistant "CR-" Series

Clippard's Corrosion-Resistant Series (CR-) incorporates materials and construction that provides enhanced protection for valves used with mildly corrosive media such as moisture in air or gases. Where stainless steel is not possible, plating is incorporated to add life to wear components. A nickel-plated brass valve body is standard, but stainless steel may be substituted.

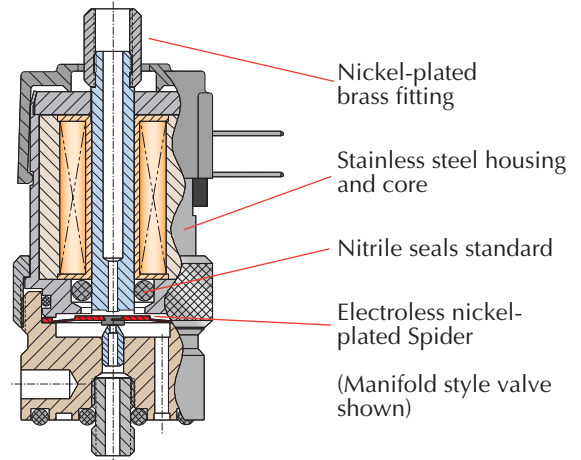

- Nickel-plated brass fitting
 - Stainless steel housing and core
 - Nitrile seals standard
 - Electroless nickel-plated Spider
- (Manifold style valve shown)



Analytical "A-" Series

Clippard's Electronic Analytical Valve (A-) series combines the proven features of the "Mouse" series with the specific needs of the analytical industry, and for applications where cleanliness is especially important. Special materials, manufacturing and assembly processes make this valve perfectly suited for applications where internal cleanliness, bubble-tight operation, and long life are imperative.

For more information, visit clippard.com/analytical

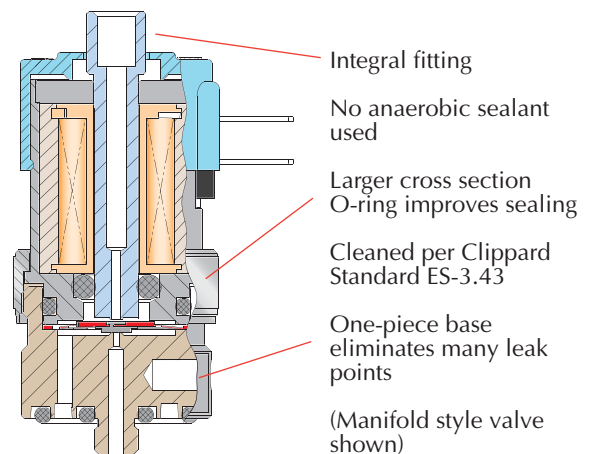

- Integral fitting
 - No anaerobic sealant used
 - Larger cross section O-ring improves sealing
 - Cleaned per Clippard Standard ES-3.43
 - One-piece base eliminates many leak points
- (Manifold style valve shown)



Oxygen Clean "O-" Series

All EV, ET, EC and EW series electronic valves with the "O-" part number option are available manufactured and assembled for use in Oxygen-enriched environments for applications that are extremely sensitive to contamination.

- Valves are ultrasonically cleaned, assembled, inspected and tested in an enclosed controlled area with a state-of-the-art positive pressure HEPA filtration system
- Both organic and inorganic contaminants such as particulate matter and Hydrocarbon oils are removed
- No organic sealants, adhesives or lubricants are used in the manufacturing process
- Component parts are lubricated with Oxygen-compatible PFPE (perfluoropolyether) grease, only as needed for assembly
- Individual testing and inspection is accomplished utilizing compressed Nitrogen and ultra-violet light

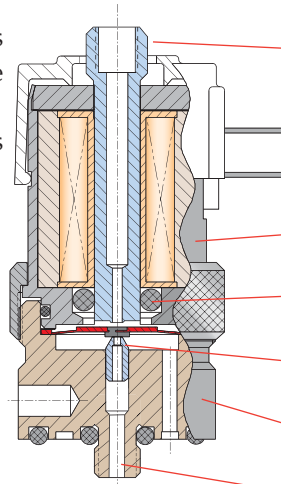

- Integral fitting
No thread sealant
- All wetted parts
cleaned per Clippard
Standard ES-3.41
- Electroless nickel-plated
steel housing and core
- FKM seals
- Stainless steel
nozzle
- Electroless nickel-
plated brass body
- Integral stud
No thread sealant
- PFPE lubricant

(Manifold style valve
shown)

For more information
on the process, visit
www.clippard.com/oxygen



ECN, EVN, ETN Mouse Valves

Normally-Open, manifold mount to allow Normally-Closed and Normally-Open valves on the same manifold. See [page 187](#) for ordering information.

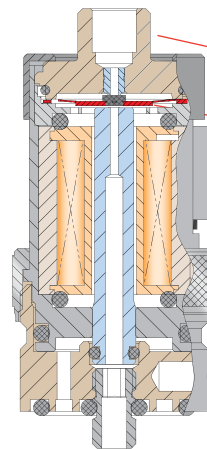

- Integral fitting
- Armature "spider"
above coil
- Mounts side-
by-side with
Normally-Closed
version
- (Manifold style
valve shown)

Custom EV Valves

Don't see it here? Call us! Many people shy away from asking for customized products and fear increased price and lead times. Clippard's electronic valve production consist of nearly 50% customized product. From the simple tweaks to complex challenges, Clippard is your partner for finding the right solution to your needs.



Metric line available. Visit www.clippard.com



MOUNTING OPTIONS & FLOW DIAGRAMS

Electrical Connection Options



0.025" Pin Connector

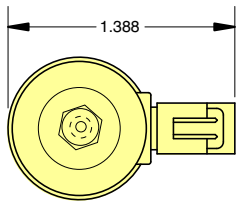

Spade Terminals

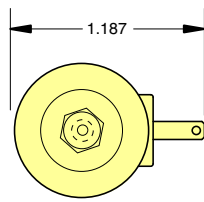

Wire Leads Side (Radial)

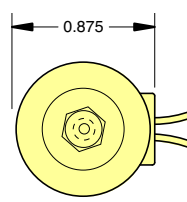

Wire Leads Top (Axial)

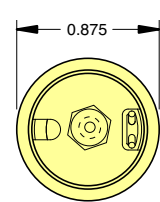

In-Line Mount

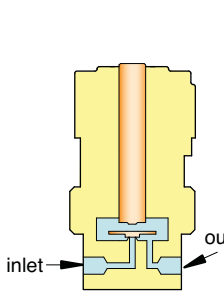

2-Way Normally-Closed In-Line Mount

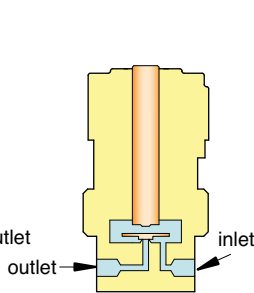

2-Way Normally-Closed High Flow In-Line Mount

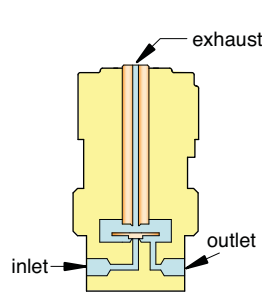

3-Way Normally-Closed In-Line Mount

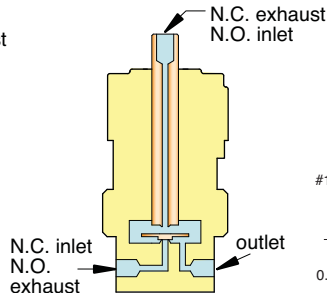

3-Way Fully-Ported In-Line Mount

Mounting Options

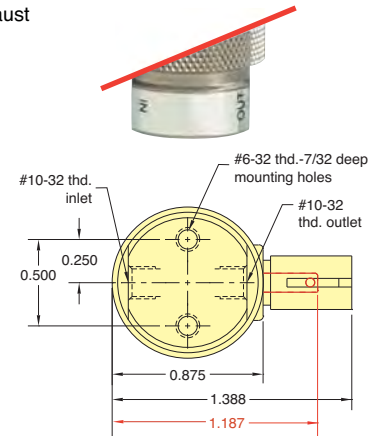

Manifold Mount

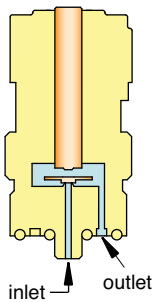

2-Way Normally-Closed Manifold Mount

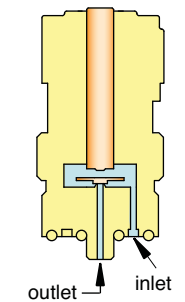

2-Way Normally-Closed High Flow Manifold Mount

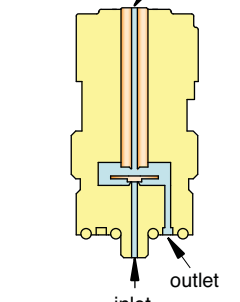

3-Way Normally-Closed Manifold Mount

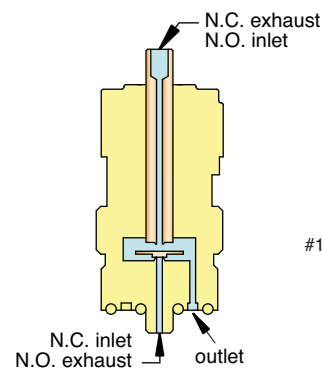

3-Way Fully-Ported Manifold Mount

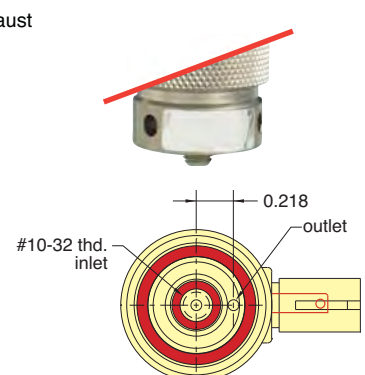



Typical Air Flow

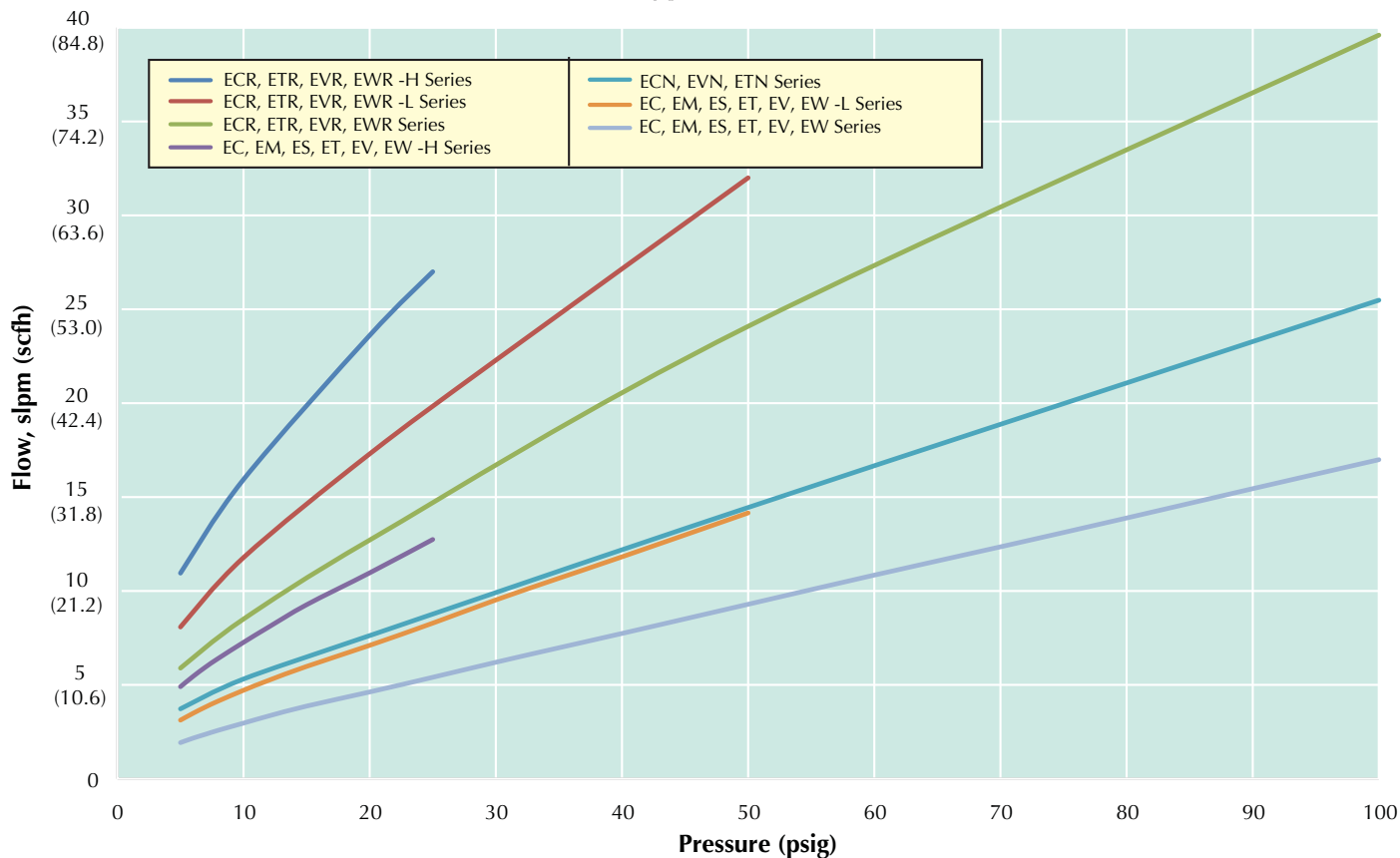

Electrical Specifications

Series	Nominal			Power (watts)	Working Range (cont. duty)
	Voltage	Current (amps)	Resistance (ohms)		
- Standard - Oxygen Clean - Analytical	12	0.055	218	0.67	90 to 150% of rated voltage
	24	0.028	864		
- Corrosion-Resistant	12	0.098	122	1.2	90 to 110% of rated voltage
	24	0.049	486		
- EM Series - ES Series	12	0.083	144	1.0	90 to 120% of rated voltage
	24	0.042	576		

Metric line available. Visit www.clippard.com



2-WAY NORMALLY-CLOSED VALVES, IN-LINE & MANIFOLD MOUNT

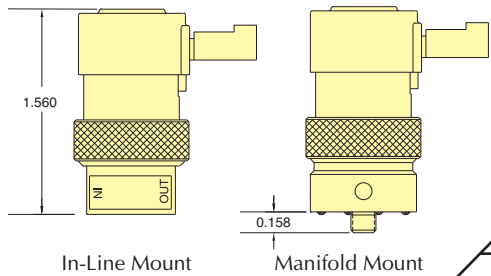

In-Line Mount	Manifold Mount	Pressure Range		Voltage		Part No.	
		Vac. to 105 psig	Vac. to 50 psig	Vac. to 25 psig	12 VDC	24 VDC	In-Line Mount
		•	•	•	•	* EC-2-12	* EC-2M-12
		•	•	•	•	* EC-2-24	* EC-2M-24
		•	•	•	•	* EC-2-12-L	* EC-2M-12-L
		•	•	•	•	* EC-2-24-L	* EC-2M-24-L
		•	•	•	•	* EC-2-12-H	* EC-2M-12-H
•	•	•	•	* EC-2-24-H	* EC-2M-24-H		
		•	•	•	•	* ET-2-12	* ET-2M-12
		•	•	•	•	* ET-2-24	* ET-2M-24
		•	•	•	•	* ET-2-12-L	* ET-2M-12-L
		•	•	•	•	* ET-2-24-L	* ET-2M-24-L
		•	•	•	•	* ET-2-12-H	* ET-2M-12-H
•	•	•	•	* ET-2-24-H	* ET-2M-24-H		
		•	•	•	•	* EV-2-12	* EV-2M-12
		•	•	•	•	* EV-2-24	* EV-2M-24
		•	•	•	•	* EV-2-12-L	* EV-2M-12-L
		•	•	•	•	* EV-2-24-L	* EV-2M-24-L
		•	•	•	•	* EV-2-12-H	* EV-2M-12-H
•	•	•	•	* EV-2-24-H	* EV-2M-24-H		
		•	•	•	•	* EW-2-12	* EW-2M-12
		•	•	•	•	* EW-2-24	* EW-2M-24
		•	•	•	•	* EW-2-12-L	* EW-2M-12-L
		•	•	•	•	* EW-2-24-L	* EW-2M-24-L
		•	•	•	•	* EW-2-12-H	* EW-2M-12-H
•	•	•	•	* EW-2-24-H	* EW-2M-24-H		

- Medium:** Clean, dry air (40 micron filter)
- Power Consumption:** 0.67 watt (CR Series: 1.2 watt)
- Temperature Range:** 32 to 180°F; CR Series: 32 to 150°F
- Response:** 5 to 10 milliseconds (nominal)
- Operating Range:** 90 to 150% of rated voltage (CR Series: ±10%)
- Ports:** #10-32



Valve Series (*)	Standard	Non-Standard
Standard	(blank)	
Oxygen Clean	O-	See Pages 179 & 180 for further information
Analytical Series**	A-	
Corrosion-Resistant (not std. on "EW")	CR-	
Options (add to end of Part No.)		
FKM Seals	-V	
EPR Seals		-E
Silicone Seals		-S
Diode		-D

Example Part No's:
ET-2M-12-V
CR-ET-2-12

See [Page 181](#) for mounting options

** Available on manifold mount valves only

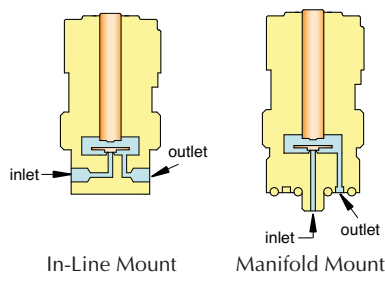

Pressure Range	Suffix	Air Flow
28" Hg Vac. to 105 psig	(blank)	0.6 scfm @ 100 psig
28" Hg Vac. to 50 psig	-L	0.5 scfm @ 50 psig
28" Hg Vac. to 25 psig	-H	0.45 scfm @ 25 psig

2-WAY NORMALLY-CLOSED HIGH FLOW VALVES, IN-LINE & MANIFOLD MOUNT

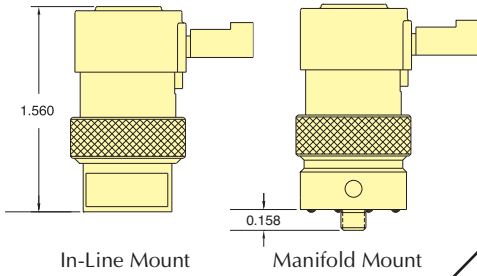

Part No.

		Pressure Range			Voltage		In-Line Mount	Manifold Mount
		Vac. to 105 psig	Vac. to 50 psig	Vac. to 25 psig	12 VDC	24 VDC		
 0.025" Pin Connector	•				•		* ECR-2-12	* ECR-2M-12
	•				•		* ECR-2-24	* ECR-2M-24
		•			•		* ECR-2-12-L	* ECR-2M-12-L
		•			•		* ECR-2-24-L	* ECR-2M-24-L
			•		•		* ECR-2-12-H	* ECR-2M-12-H
			•	•			* ECR-2-24-H	* ECR-2M-24-H
 Spade Terminals	•				•		* ETR-2-12	* ETR-2M-12
	•				•		* ETR-2-24	* ETR-2M-24
		•			•		* ETR-2-12-L	* ETR-2M-12-L
		•			•		* ETR-2-24-L	* ETR-2M-24-L
			•		•		* ETR-2-12-H	* ETR-2M-12-H
			•	•			* ETR-2-24-H	* ETR-2M-24-H
 Wire Leads Side (Radial)	•				•		* EVR-2-12	* EVR-2M-12
	•				•		* EVR-2-24	* EVR-2M-24
		•			•		* EVR-2-12-L	* EVR-2M-12-L
		•			•		* EVR-2-24-L	* EVR-2M-24-L
			•		•		* EVR-2-12-H	* EVR-2M-12-H
			•	•			* EVR-2-24-H	* EVR-2M-24-H
 Wire Leads Top (Axial)	•				•		* EWR-2-12	* EWR-2M-12
	•				•		* EWR-2-24	* EWR-2M-24
		•			•		* EWR-2-12-L	* EWR-2M-12-L
		•			•		* EWR-2-24-L	* EWR-2M-24-L
			•		•		* EWR-2-12-H	* EWR-2M-12-H
			•	•			* EWR-2-24-H	* EWR-2M-24-H

Medium: Clean, dry air (40 micron filter)

Power Consumption: 1.2 watt

Temperature Range: 32 to 150°F

Response: 10 milliseconds (nominal)

Operating Range: ±10% of rated voltage

Ports: #10-32



Valve Series (*)	Standard	Non-Standard
Standard Analytical Series**	(blank) A-	See Pages 179 & 180 for further information
Options (add to end of Part No.)		
FKM Seals	-V	
EPR Seals		-E
Silicone Seals		-S
Diode		-D

See [Page 181](#) for mounting options

** Available on manifold mount valves only

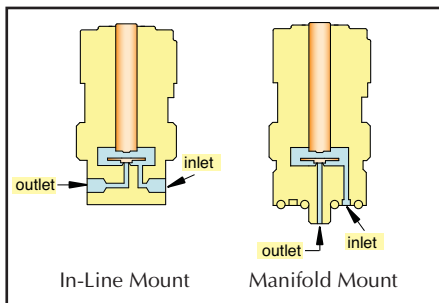

Pressure Range	Suffix	Air Flow
28" Hg Vac. to 100 psig	(blank)	1.4 scfm @ 100 psig
28" Hg Vac. to 50 psig	-L	1.1 scfm @ 50 psig
28" Hg Vac. to 25 psig	-H	0.95 scfm @ 25 psig

Metric line available. Visit www.clippard.com



3-WAY NORMALLY-CLOSED VALVES, IN-LINE & MANIFOLD

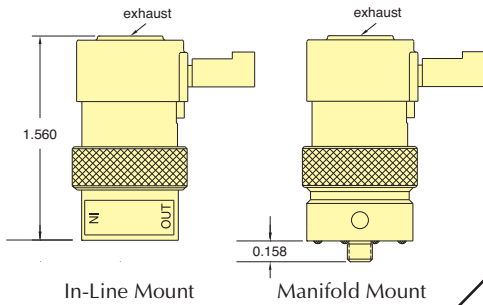

		Pressure Range		Voltage		Part No.	
		Vac. to 105 psig		Vac. to 50 psig		Vac. to 25 psig	
		12 VDC		24 VDC			
		In-Line Mount		Manifold Mount			
 0.025" Pin Connector		•	•	•	•	* EC-3-12	* EC-3M-12
		•	•	•	•	* EC-3-24	* EC-3M-24
		•	•	•	•	* EC-3-12-L	* EC-3M-12-L
		•	•	•	•	* EC-3-24-L	* EC-3M-24-L
		•	•	•	•	* EC-3-12-H	* EC-3M-12-H
•	•	•	•	* EC-3-24-H	* EC-3M-24-H		
 Spade Terminals		•	•	•	•	* ET-3-12	* ET-3M-12
		•	•	•	•	* ET-3-24	* ET-3M-24
		•	•	•	•	* ET-3-12-L	* ET-3M-12-L
		•	•	•	•	* ET-3-24-L	* ET-3M-24-L
		•	•	•	•	* ET-3-12-H	* ET-3M-12-H
•	•	•	•	* ET-3-24-H	* ET-3M-24-H		
 Wire Leads Side (Radial)		•	•	•	•	* EV-3-12	* EV-3M-12
		•	•	•	•	* EV-3-24	* EV-3M-24
		•	•	•	•	* EV-3-12-L	* EV-3M-12-L
		•	•	•	•	* EV-3-24-L	* EV-3M-24-L
		•	•	•	•	* EV-3-12-H	* EV-3M-12-H
•	•	•	•	* EV-3-24-H	* EV-3M-24-H		
 Wire Leads Top (Axial)		•	•	•	•	* EW-3-12	* EW-3M-12
		•	•	•	•	* EW-3-24	* EW-3M-24
		•	•	•	•	* EW-3-12-L	* EW-3M-12-L
		•	•	•	•	* EW-3-24-L	* EW-3M-24-L
		•	•	•	•	* EW-3-12-H	* EW-3M-12-H
•	•	•	•	* EW-3-24-H	* EW-3M-24-H		

- Medium:** Clean, dry air (40 micron filter)
- Power Consumption:** 0.67 watt (CR Series: 1.2 watt)
- Temperature Range:** 32 to 180°F, CR Series: 32 to 150°F
- Response:** 5 to 10 milliseconds (nominal)
- Operating Range:** 90 to 150% of rated voltage (CR Series: ±10%)
- Ports:** #10-32

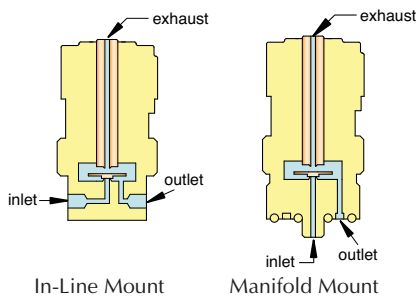

Valve Series (*)	Standard	Non-Standard
Standard	(blank)	
Oxygen Clean	O-	See Pages 179 & 180 for further information
Analytical Series**	A-	
Corrosion-Resistant (not std. on "EW")	CR-	
Options (add to end of Part No.)		
FKM Seals	-V	
EPR Seals		-E
Silicone Seals		-S
Diode		-D

Example Part No's:
ET-3-12-S
O-EW-3-24

See [Page 181](#) for mounting options

** Available on manifold mount valves only

Pressure Range	Suffix	Air Flow
28" Hg Vac. to 105 psig	(blank)	0.6 scfm @ 100 psig
28" Hg Vac. to 50 psig	-L	0.5 scfm @ 50 psig
28" Hg Vac. to 25 psig	-H	0.45 scfm @ 25 psig

3-WAY FULLY-PORTED VALVES, IN-LINE & MANIFOLD

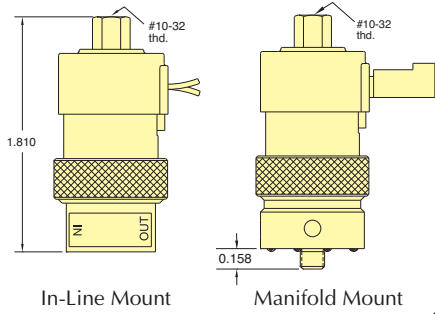

Part No.

		Pressure Range		Voltage		In-Line Mount	Manifold Mount
		Vac. to 105 psig	Vac. to 50 psig	Vac. to 25 psig	12 VDC	24 VDC	
 0.025" Pin Connector	•	•	•	•	•	*ECO-3-12	*ECO-3M-12
	•	•	•	•	•	*ECO-3-24	*ECO-3M-24
	•	•	•	•	•	*ECO-3-12-L	*ECO-3M-12-L
	•	•	•	•	•	*ECO-3-24-L	*ECO-3M-24-L
	•	•	•	•	•	*ECO-3-12-H	*ECO-3M-12-H
	•	•	•	•	•	*ECO-3-24-H	*ECO-3M-24-H
 Spade Terminals	•	•	•	•	•	*ETO-3-12	*ETO-3M-12
	•	•	•	•	•	*ETO-3-24	*ETO-3M-24
	•	•	•	•	•	*ETO-3-12-L	*ETO-3M-12-L
	•	•	•	•	•	*ETO-3-24-L	*ETO-3M-24-L
	•	•	•	•	•	*ETO-3-12-H	*ETO-3M-12-H
	•	•	•	•	•	*ETO-3-24-H	*ETO-3M-24-H
 Wire Leads Side (Radial)	•	•	•	•	•	*EVO-3-12	*EVO-3M-12
	•	•	•	•	•	*EVO-3-24	*EVO-3M-24
	•	•	•	•	•	*EVO-3-12-L	*EVO-3M-12-L
	•	•	•	•	•	*EVO-3-24-L	*EVO-3M-24-L
	•	•	•	•	•	*EVO-3-12-H	*EVO-3M-12-H
	•	•	•	•	•	*EVO-3-24-H	*EVO-3M-24-H
 Wire Leads Top (Axial)	•	•	•	•	•	*EWO-3-12	*EWO-3M-12
	•	•	•	•	•	*EWO-3-24	*EWO-3M-24
	•	•	•	•	•	*EWO-3-12-L	*EWO-3M-12-L
	•	•	•	•	•	*EWO-3-24-L	*EWO-3M-24-L
	•	•	•	•	•	*EWO-3-12-H	*EWO-3M-12-H
	•	•	•	•	•	*EWO-3-24-H	*EWO-3M-24-H

Medium: Clean, dry air (40 micron filter)

Power Consumption: 0.67 watt (CR Series: 1.2 watt)

Temperature Range: 32 to 180°F, CR Series: 32 to 150°F

Response: 5 to 10 milliseconds (nominal)

Operating Range: 90 to 150% of rated voltage (CR Series: ±10%)

Ports: #10-32

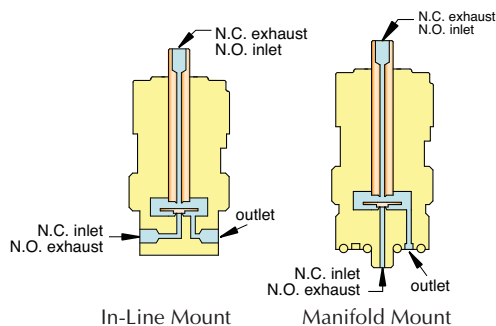

Valve Series (*)	Standard	Non-Standard
Standard	(blank)	
Oxygen Clean	O-	See Pages 179 & 180 for further information
Analytical Series**	A-	
Corrosion-Resistant (not std. on "EWO")	CR-	
Options (add to end of Part No.)		
FKM Seals	-V	
EPR Seals		-E
Silicone Seals		-S
Diode		-D

Example Part No's:
ETO-3M-24-D
CR-EVO-3-12

See Page 181 for mounting options



** Available on manifold mount valves only

Pressure Range	Suffix	Air Flow
28" Hg Vac. to 105 psig	(blank)	0.6 scfm @ 100 psig
28" Hg Vac. to 50 psig	-L	0.5 scfm @ 50 psig
28" Hg Vac. to 25 psig	-H	0.45 scfm @ 25 psig

Metric line available. Visit www.clippard.com

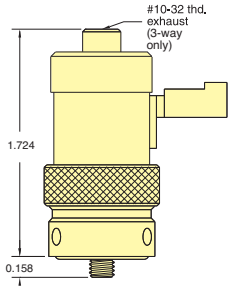

2-WAY & 3-WAY NORMALLY-OPEN VALVES, MANIFOLD

		Voltage		Part No.	
		12 VDC	24 VDC	2-Way	3-Way
 0.025" Pin Connector	•		ECN-2M-12	ECN-3M-12	
		•	ECN-2M-24	ECN-3M-24	
 Spade Terminals	•		ETN-2M-12	ETN-3M-12	
		•	ETN-2M-24	ETN-3M-24	
 Wire Leads Side (Radial)	•		EVN-2M-12	EVN-3M-12	
		•	EVN-2M-24	EVN-3M-24	

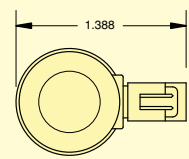
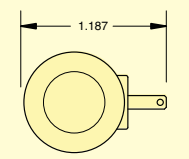
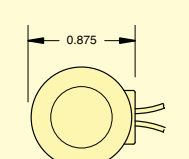
- Medium:** Clean, dry air (40 micron filter)
- Power Consumption:** 0.67 watt
- Temperature Range:** 32 to 180°F
- Response:** 5 to 10 milliseconds (nominal)
- Operating Range:** 90 to 150% of rated voltage
- Voltage:** 12 VDC or 24 VDC. Other voltages available upon request.
- Ports:** #10-32



Valve Series (*)	Standard	Non-Standard
Standard	(blank)	
Options (add to end of Part No.)		
FKM Seals	-V	
EPR Seals		-E
Silicone Seals		-S
Diode		-D

Example Part No's:
[EVN-2M-12-V](#)
[ETN-3M-24](#)

See Page 181 for mounting options

Pressure Range	Air Flow
28" Hg Vac. to 105 psig	0.9 scfm @ 100 psig

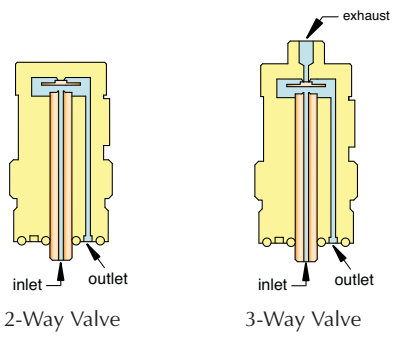

2- & 3-WAY INTRINSICALLY SAFE VALVES



2-WAY INTRINSICALLY SAFE NORMALLY-CLOSED VALVES, IN-LINE & MANIFOLD MOUNT

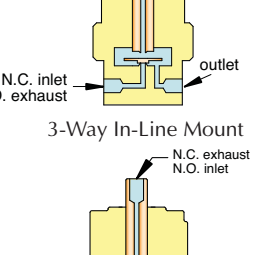
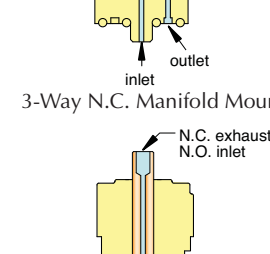
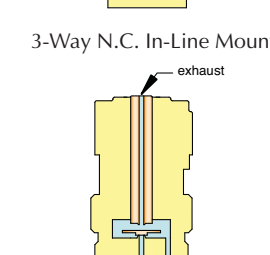
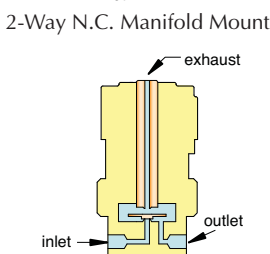
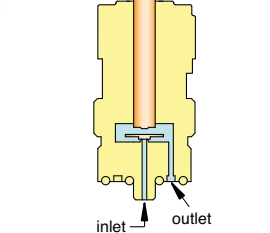
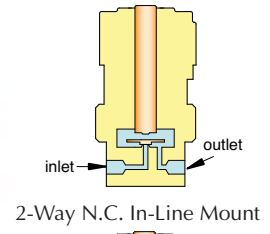
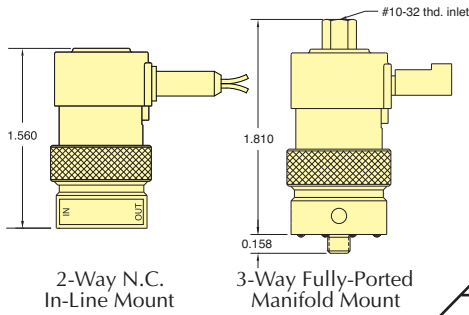

Pressure Range	Part No.	
	In-Line Mount	Manifold Mount
Vac. to 105 psig	EI-2-15.5	EI-2M-15.5
	EI-2-15.5-L	EI-2M-15.5-L
	EI-2-15.5-H	EI-2M-15.5-H
Vac. to 50 psig	EI-2-15.5-C	EI-2M-15.5-C
	EI-2-15.5-LC	EI-2M-15.5-LC
	EI-2-15.5-HC	EI-2M-15.5-HC
Vac. to 25 psig	EI-2-15.5-C	EI-2M-15.5-C
	EI-2-15.5-LC	EI-2M-15.5-LC
	EI-2-15.5-HC	EI-2M-15.5-HC

3-WAY INTRINSICALLY SAFE NORMALLY-CLOSED VALVES, IN-LINE & MANIFOLD MOUNT

Pressure Range	Part No.	
	In-Line Mount	Manifold Mount
Vac. to 105 psig	EI-3-15.5	EI-3M-15.5
	EI-3-15.5-L	EI-3M-15.5-L
	EI-3-15.5-H	EI-3M-15.5-H
Vac. to 50 psig	EI-3-15.5-C	EI-3M-15.5-C
	EI-3-15.5-LC	EI-3M-15.5-LC
	EI-3-15.5-HC	EI-3M-15.5-HC
Vac. to 25 psig	EI-3-15.5-C	EI-3M-15.5-C
	EI-3-15.5-LC	EI-3M-15.5-LC
	EI-3-15.5-HC	EI-3M-15.5-HC

3-WAY INTRINSICALLY SAFE FULLY-PORTED VALVES, IN-LINE & MANIFOLD MOUNT

Pressure Range	Part No.	
	In-Line Mount	Manifold Mount
Vac. to 105 psig	EIO-3-15.5	EIO-3M-15.5
	EIO-3-15.5-L	EIO-3M-15.5-L
	EIO-3-15.5-H	EIO-3M-15.5-H
Vac. to 50 psig	EIO-3-15.5-C	EIO-3M-15.5-C
	EIO-3-15.5-LC	EIO-3M-15.5-LC
	EIO-3-15.5-HC	EIO-3M-15.5-HC
Vac. to 25 psig	EIO-3-15.5-C	EIO-3M-15.5-C
	EIO-3-15.5-LC	EIO-3M-15.5-LC
	EIO-3-15.5-HC	EIO-3M-15.5-HC

Medium: Clean, dry air (40 micron filter)

Power Consumption: 0.67 watt

Temperature Range: 32 to 180°F

Response: 5 to 10 milliseconds (nominal)

Operating Range: 90 to 150% of rated voltage

Voltage: 15.5 VDC

Ports: #10-32 and manifold mount



Pressure Range	Suffix	Air Flow
28" Hg Vac. to 105 psig	(blank)	0.6 scfm @ 100 psig
28" Hg Vac. to 50 psig	-L	0.5 scfm @ 50 psig
28" Hg Vac. to 25 psig	-H	0.45 scfm @ 25 psig

See [Page 181](#) for mounting options

Other seal materials optional

See www.clippard.com for more information



EV, ET, EC, EW SERIES HIGHER FLOW VALVES

EC, EV, ET & EW PILOTED 2-WAY & 3-WAY NORMALLY-CLOSED, PRESSURE PILOTED VALVES, MANIFOLD MOUNT

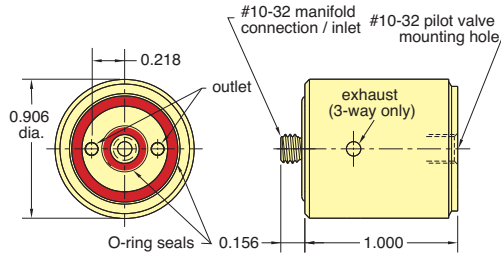

Medium: Air

Materials: Nickel-plated brass, acetal, stainless steel and Nitrile

Response: 20 milliseconds @ 20 psig;
13 milliseconds @ 100 psig nominal

Ports: Inlet and outlet through manifold

Material: Nickel-plated brass, acetal, stainless steel and Nitrile

Note: Use only Normally-Closed 3-Way Pilot valves in conjunction with EVB-2/EVB-3

Part No.

- EVB-2 2-Way Valve Booster
- EVB-3 3-Way Valve Booster

Input Pressure	Air Flow
20 to 150 psig	6.1 scfm @ 100 psig

ELECTRONIC INTERFACE 3-WAY NORMALLY-CLOSED VALVE

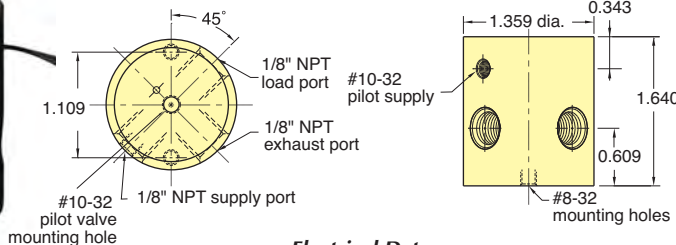

Medium: Air

Filtration: 10 micron

Ports: 1/8" NPT female

Switching Speed: 10 milliseconds

Bleed Flow: 0.10 scfm @ 100 psig

Frequency Response: 50 Hz @ 100 psig;
70 Hz @ 30 psig

Part No.

- 2013-6 Interface Valve, 6 VDC
- 2013-12 Interface Valve, 12 VDC
- 2013-24 Interface Valve, 24 VDC

Continuous Overload: 350% @ 25°C ambient; 250% @ 50°C ambient

Power Consumption: Less than 0.50 watts @ rated voltage (80 ma. @ 6 VDC, 40 ma. @ 12 VDC 20 ma. @ 24VDC)

Leads: 28 gauge stranded PVC insulated

Input Pressure	Air Flow
30 to 100 psig	22 scfm @ 100 psig
<i>call for special configurations</i>	

3-WAY NORMALLY-CLOSED, PRESSURE PILOTED VALVES

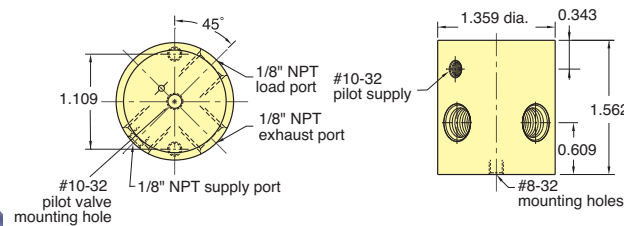

Medium: Air

Pilot Pressure: (2020) 60% of supply pressure, minimum

Response: Approximately 20 milliseconds

Mounting: Mounting holes provided

Ports: Inlet and outlet, exhaust 1/8" NPT Pilot supply on 2020 is #10-32 female

Materials: Anodized Aluminum, Stainless Steel and Nitrile

Additional Note: Use only Normally-Closed 3-way pilot valves in conjunction with 2020/2021

Designed to be piloted by a Clippard EC, EV and ET manifold mount electronic valve (not included). Output from the EC, EV and ET actuates the valve to produce outputs up to 22 scfm at 100 psig. Combines low wattage, long life and cool running of the EC, EV and ET valves with quick response and high flow of Clippard "Fluidamp" type valves. The 2020 and 2021 are identical in all respects except one. The 2020 has an external #10-32 pilot port.

Part No.

- 2020 External Piloted Valve with #10-32 Port
- 2021 Internal Piloted Valve

Input Pressure	Air Flow
30 to 100 psig	22 scfm @ 100 psig
<i>call for special configurations</i>	

ET PILOTED 4-WAY VALVES & CONNECTORS



4-WAY PILOTED VALVES

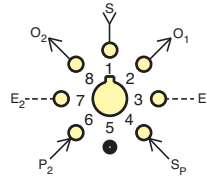
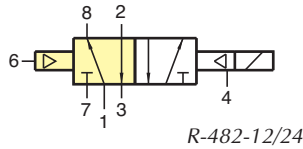
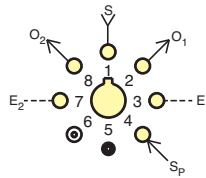
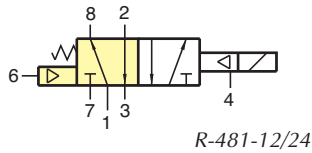

Type: 4-way combination electronic and modular spool type interface valve. Fully-ported ET-3 & R-401 (R-481)/R-402 (R-482) hybrid

Medium: Air, water, or oil; pilot - air only

Mounting: Uses Octoport base and two captivated screws

Ports: Valve has patented Octoport system

Note: Supply pressure must be applied to both ports 1 and 4. Minimum pressure on port 4 should be 40 psig.

Part No.

<u>R-481-12</u>	ET-3/R-401, 12 VDC
<u>R-481-24</u>	ET-3/R-401, 24 VDC
<u>R-482-12</u>	ET-3/R-402, 12 VDC
<u>R-482-24</u>	ET-3/R-402, 24 VDC

Input Pressure	Air Flow
Pilot: 40 psig min.	9 scfm @ 100 psig
Working: 0 to 150 psig	

For more information please see Page 270 in the Modular Valve section of this catalog.

ET VALVE CONNECTORS

Black molded lug connectors are available for easy push-on connection ET-C48 is 48" in length, ET-C120 is 120" in length.



Insulated crimp-on spade lug connectors are available for wiring up leads to connect an electronic circuit to ET style valves. Accepts #22, #24, or #26 wire.



Part No.

<u>ET-C48</u>	48" Connector
<u>ET-C120</u>	120" Connector

Part No.

3831 Spade Lug Connector

EC & EI VALVE CONNECTORS

TE Connectivity #5-103956-1 with 18" or 120" wire leads for EC/ECO and EI/EIO valves.

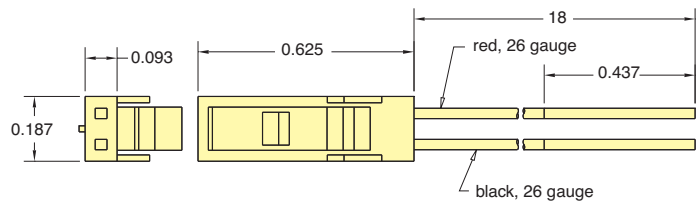

Part No.

<u>C2-RB18</u>	18" Connector
<u>C2-RB120</u>	120" Connector



CUSTOM PORTS & CONNECTORS

If you need a product that fits your application perfectly, Clippard has the capability to design or modify one of its products to suit your exact needs.

This application requires a special connection to a MAPP gas canister. The valve is tested for response time and flow rate, which delivers a consistent amount of gas each cycle.

CUSTOMer solutions

Metric line available. Visit www.clippard.com



EV, ET, EC, EW SERIES ACCESSORIES

Specialized Manifolds

Material: ENP brass Option: Oxygen Clean version (add O-)

15490-1

#10-32 Inlet
1/8" NPT Outlet

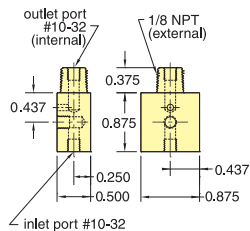

15490-2

1/8" NPT Inlet
#10-32 Outlet

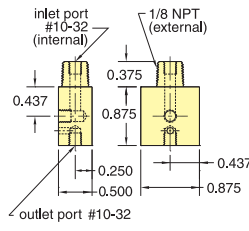

15490-3 Dual Outlet

1/8" NPT Inlet
#10-32 Outlet

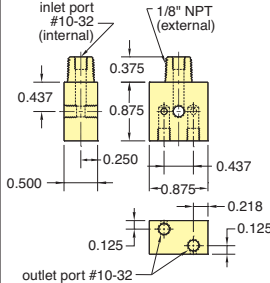

15491-1

#10-32 Inlet
1/8" NPT Outlet

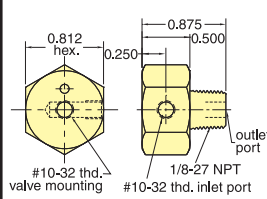

15491-2

1/8" NPT (R1/8) Inlet
#10-32 Outlet

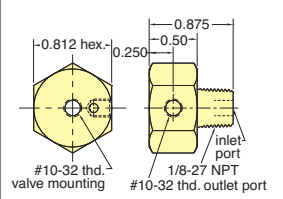

Use: Mount EV, ET, EC, and EW valves to any 1/8" NPT supply port

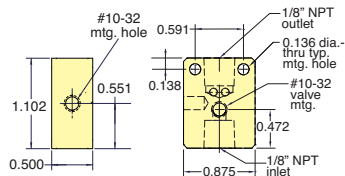

15490-5

1/8" NPT Inlet
1/8" NPT Outlet

Oxygen Clean Manifolds

Multi-station manifolds are available for use with Clippard's Oxygen Clean series electronic valves. These manifolds offer either single-sided or double-side mounting in Oxygen-compatible ENP brass material.

The Oxygen series products are manufactured and assembled for applications in Oxygen-enriched environments which are extremely sensitive to contamination. Each manifold is cleaned according to Clippard Specification #ES-3.41, and double bagged in heat-sealed polyethylene bags.



Input Ports: In-line 1/8" NPT

Outlet Ports: #10-32

Mounting: #10-32 tapped holes

Materials: ENP Brass

Single-Sided		Double-Sided		Length "A"	Mtg. "L"	"M"
Part No.	Stations	Part No.	Stations			
O-15581-2*	2	O-15582-8*	8	0.444	1.826	0.937
O-15581-4*	4	O-15582-8*	8	0.913	3.702	1.875
O-15581-6*	6	O-15582-12*	12	0.913	5.577	3.750

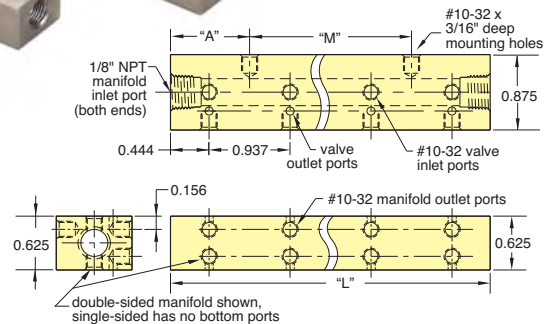

Multi-Valve Manifolds

Construction: Black anodized aluminum



Single-Sided		Double-Sided		Length "A"	Mtg. "L"	"M"
Part No.	Stations	Part No.	Stations			
15481-2	2	15482-8	8	0.444	1.826	0.937
15481-4	4	15482-8	8	0.913	3.702	1.875
15481-6	6	15482-12	12	0.913	5.577	3.750

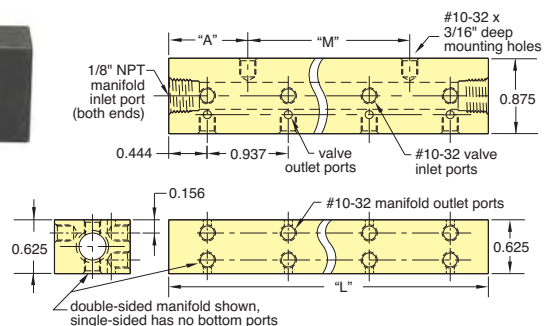



Auxiliary Power Input

Power to operate the valves may be provided through two sources: ONE, through the 25-pin connector if your signal source also has sufficient power to operate the bank of valves, or TWO, through a separate auxiliary power input connection built into the board. To isolate power from the 25-pin connector, use the power source selector switch.

NOTE: In applying power on a temporary basis, use care to observe proper circuit polarity.

Reverse Polarity Protection

Circuit using diodes and capacitor provides input voltage protection against reverse polarity.

Resistor-Diode-LED Circuit

Individual circuit to each valve provides protection against shut-off spikes. LED is illuminated when valve is actuated.

Printed Circuit Board

Durable laminated fiberglass

3-Position Detented Switches

Three position slide switch provides for: ON - Power "ON"; valve is activated; OFF - Power "OFF"; valve not connected; CONN - Valve connected to 25-pin connector, and will be controlled through it.

Power Selector Switch

Two-position selector switch enables choice of power input source (25-pin connector or auxiliary).

25-Pin Connector

Clippard Electronic Valves

Clippard Valve Manifold

Compact, efficient mounting of the valves is by Clippard multi-valve manifolds.

LED Bank

Illuminated LED signals that the valve is actuated.

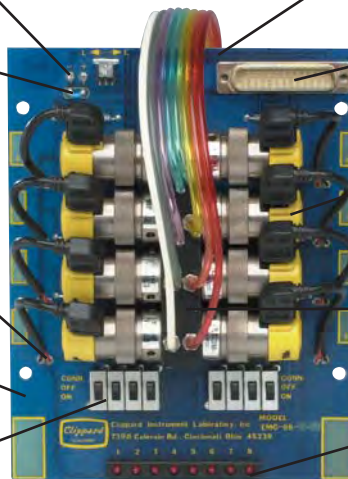

Clippard Electronic Manifold Cards

Now you can direct low-voltage DC signals from controllers, systems, computers or other sources to operate powerful pneumatic valves with a minimum of piping and hook-up.

Self-contained card includes:

- 8 or 12 Clippard ET interface valves
- Manifold mount for single air supply
- Circuit board fully wired
- Instant plug-in with 25-pin connector
- Resistor, diode, LED and switch for each valve
- Auxiliary power supply connection

Ready to operate quickly. Just mount the card and make external connection. And each valve may be individually removed and replaced without any need for desoldering!

Convenience in interfacing electronics and pneumatics . . . completely assembled, manifolded valve cards.

Features

- Fast, easy to mount
- Pre-assembled; all valves mounted
- Low power requirements (0.67 watt per valve)
- Choice of valve types
- Each valve switchable
- Shut-off spike protection
- 25-pin connector
- No expensive card rack required

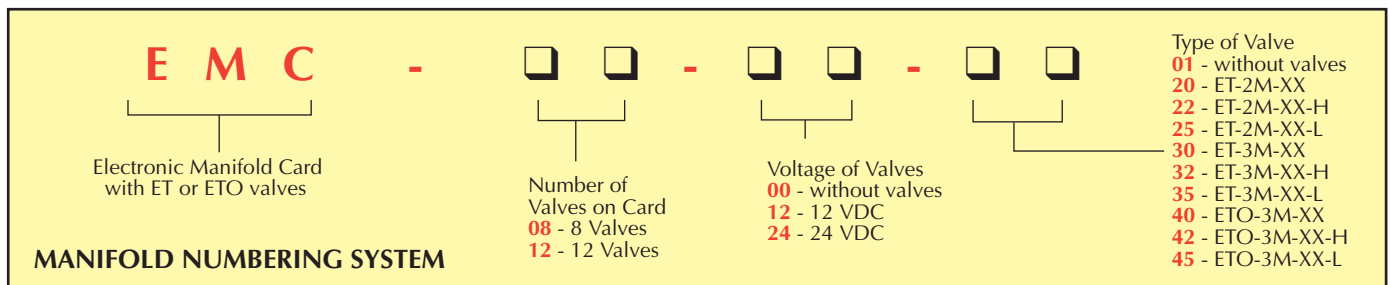

EMC-08-00-01 and EMC-12-00-01 are part numbers for cards without any valves, and without manifold. Manifold mounting hardware is included. Manifolds may be ordered separately, if desired. Part numbers are: 15482-8 and 15482-12.



ELECTRONIC MANIFOLD CARD

EMC-08

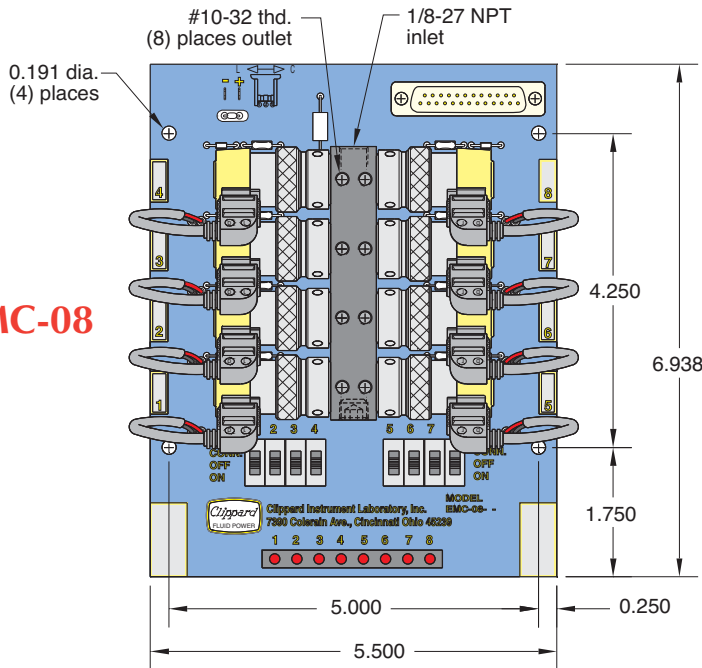

EMC-12

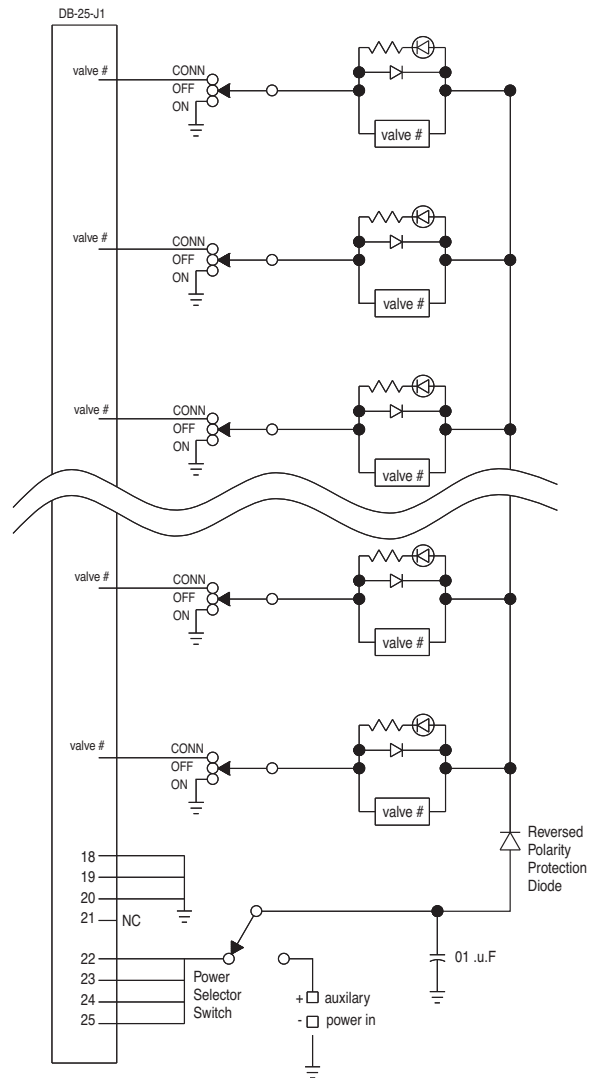
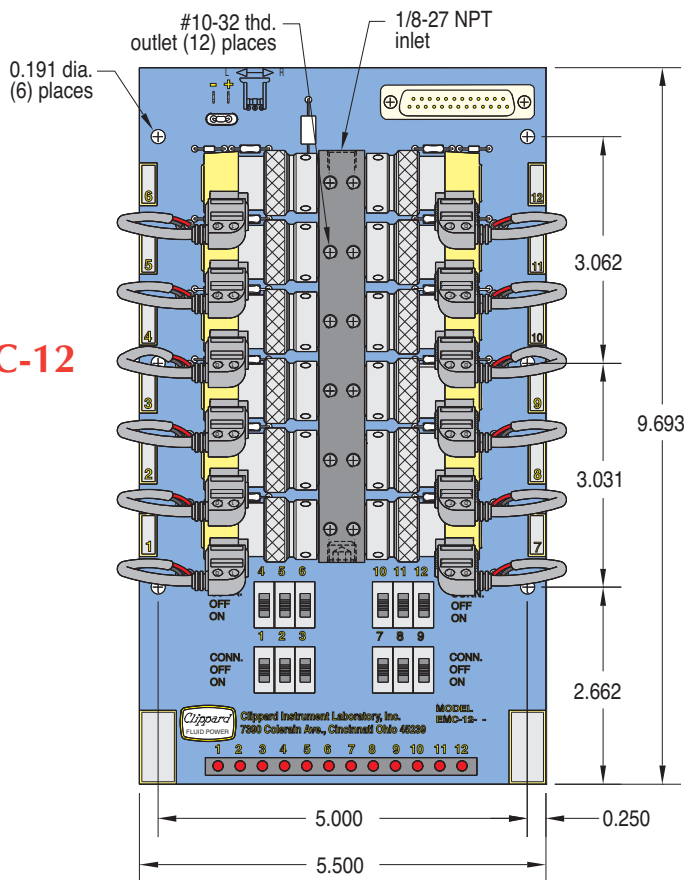

Wiring Diagram

Note: Manifold mounted valves are Normally-Closed. Use ETO models if exhaust must be ported. ETO models cannot be used "Normally-Open" without special piping.

EM STUD MOUNT 2-WAY & 3-WAY VALVES



2- & 3-WAY NORMALLY-CLOSED & 3-WAY N.O./N.C. VALVES, MANIFOLD MOUNT

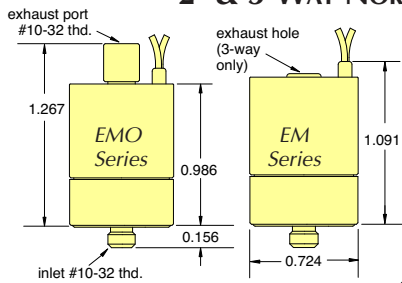

Part No.

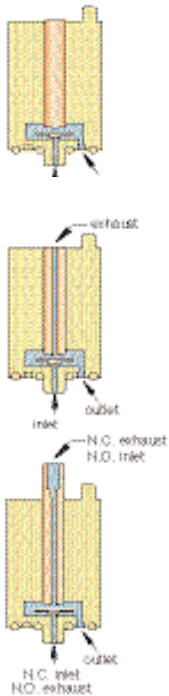

Image	Pressure Range			Voltage		2-Way N.C.	3-Way N.C.	3-Way N.O./N.C.
	Vac. to 105 psig	Vac. to 50 psig	Vac. to 25 psig	12 VDC	24 VDC			
	•	•	•	•	•	EM-2-12 EM-2-24 EM-2-12-L EM-2-24-L EM-2-12-H EM-2-24-H		
	•	•	•	•	•		EM-3-12 EM-3-24 EM-3-12-L EM-3-24-L EM-3-12-H EM-3-24-H	
	•	•	•	•	•			EMO-3-12 EMO-3-24 EMO-3-12-L EMO-3-24-L EMO-3-12-H EMO-3-24-H

Options (add to end of Part No.)	Standard	Non-Standard
FKM Seals	-V	
EPDM Seals		-E
Silicone Seals		-S

Pressure Range	Suffix	Air Flow
28" Hg Vac. to 105 psig	(blank)	0.6 scfm @ 100 psig
28" Hg Vac. to 50 psig	-L	0.5 scfm @ 50 psig
28" Hg Vac. to 25 psig	-H	0.45 scfm @ 25 psig

An even smaller Mouse valve! When space is critical, the EM Series Valve provides the best solution. At just over an inch tall, and less than 3/4" in diameter, the EM Valve uses Clippard's special "spider" design. This reliable and proven design for long life is housed in a miniature body, and incorporates wire leads out the top, allowing body rotation for close-center mounting. In addition, the valve features higher flow; combining fast shifting speed, extremely high cycle life with the design flexibility to make this valve a "small wonder" for demanding applications.

This valve is perfect for air and/or gas control, pilot control, and any application where space is limited, but desired performance is not.

Medium: Clean, dry air (40 micron filter)

Power Consumption: 1 watt

Temperature Range: 32 to 150°F

Response: 10 milliseconds at nominal voltage (15 milliseconds N.O.)

Operating Range: 90 to 120% of rated voltage

Voltage: 12 VDC or 24 VDC. Other voltages available upon request.

Ports: #10-32 Exhaust



Simply tighten valves onto the manifold using a standard 1/8" Allen hex wrench. (4-10 in.-lbs. Do not over-tighten)

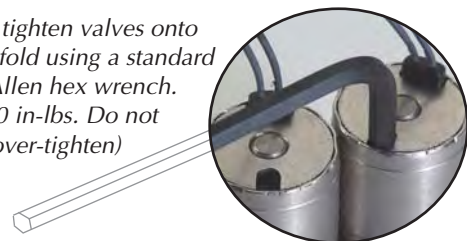

Metric line available. Visit www.clippard.com



EM STUD MOUNT VALVE MANIFOLDS

EM Series Manifolds

Construction: Black anodized aluminum



Part No.	Stations	Part No.	Stations	Length "L"	Mtg. "M"	"A"
<i>Single-Sided</i>		<i>Double-Sided</i>				
15681-2	2	15682-4	4	1.480"	0.740"	0.370"
15681-4	4	15682-8	8	2.960"	1.480"	0.740"
15681-6	6	15682-12	12	4.440"	2.960"	0.740"
15681-8	8	15682-16	16	5.920"	4.440"	0.740"

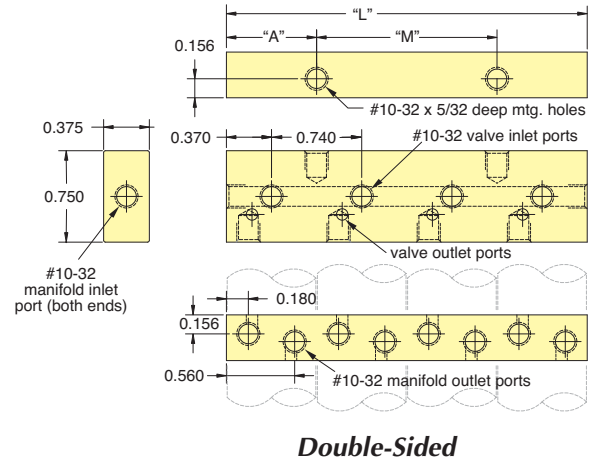
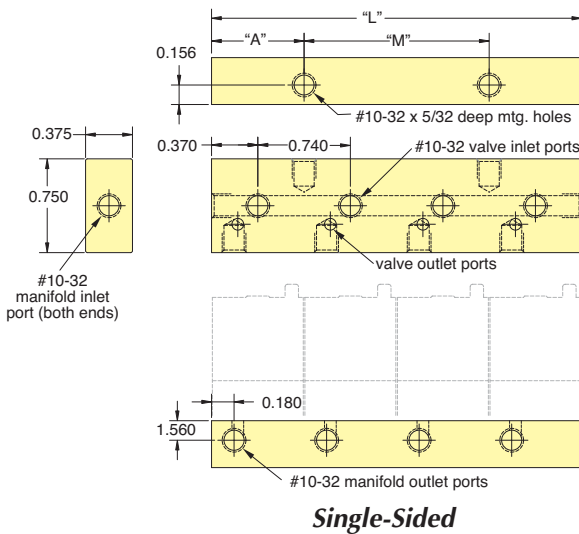

NEW! EFB Series Fill & Bleed Circuits

A Fill and Bleed Circuit is a combination of pneumatic valve components used to inflate a volume or apparatus in one controllable function, and to release or vent pressure in a second controllable function. See [Pages 210 & 211](#).



Manifold Assemblies

Our Value Added department provides assembly services for all Clippard components. If you have a need for special or standard manifolds, and would like to receive a single part number with all components assembled and tested, just contact Clippard. We provide application assistance, special testing, kitting of parts, control boxes, manifold assemblies, and more. Let our experience and capabilities work for you.



Valves are small in size with a variety of coil voltages and flow options. Mounting is as close as 7/8" on center.

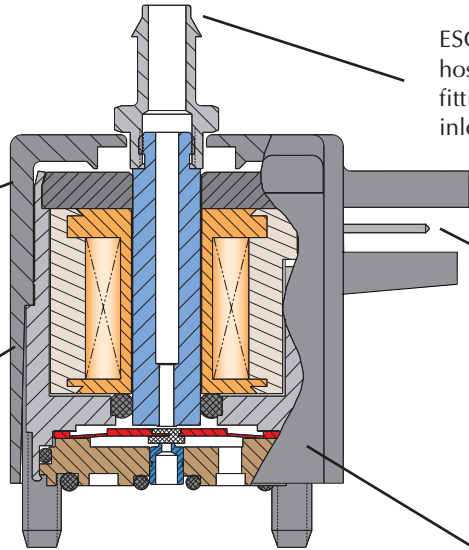

Housing is molded Zytel® ST 801 for toughness and rigidity.

Valves feature low power, cool running, quiet operation and fast response time. They convert low voltage, low current signals into high pressure pneumatic outputs.

ESO and similar styles have top hose barb or #10-32 (M5) threaded fitting for N.C. exhaust or N.O. inlet.



Coils are available to mate with TE Connectivity #5-103956-2 with connector or with 18" wire leads which utilize #26 wire.

Clippard ES valves are unique, with only one internal moving part that travels a mere 0.007".

Quality Design

The compact ES valve, like Clippard EV and ET valves, converts low voltage, low current signals into high pressure (0 to 105 psig) pneumatic outputs, utilizing a unique, patented valving principle. Since there are no sliding parts, and complete poppet travel is only 0.007", low power consumption and exceptionally long life are assured with this design. No flow is required for cooling because the compact ES is cool, as well as quiet, in operation.

The compact nature of design makes this valve well suited to a wide range of applications in biomedical, environmental test equipment, textile machines, packaging machinery, computerized industrial automation, and portable systems.



Features

- Close mounting - 7/8" on center
- Overall height less than 1"
- Easy to mount on manifold with two #4-40 screws
- Geometric design
- Polymer housing - Zytel ST 801® super tough
- TE Connectivity-style pin connection or 18" wire leads
- Flow up to 0.6 scfm

Zytel ST 801® super tough and Zytel® are a registered trademark of DuPont

NOMINAL			Power (watts)	Working Range (cont. duty)
Voltage*	Current (amps)	Resistance (ohms)		
12	0.083	144	1.0	90 to 120% of rated voltage
24	0.042	576	1.0	

*Other voltages available. Please consult factory.

Metric line available. Visit www.clippard.com



ES SERIES 2- & 3-WAY NORMALLY-CLOSED VALVES

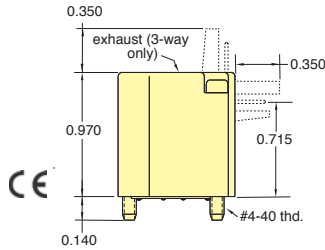

		Vac. to 105 psig		Vac. to 50 psig		Vac. to 25 psig		12 VDC		24 VDC		Part No.
		Pressure Range		Voltage		2-Way		3-Way				
 Side Pin Connector	•			•	•	ES-2S-12	ES-3S-12					
	•			•	•	ES-2S-24	ES-3S-24					
		•		•	•	ES-2S-12-L	ES-3S-12-L					
		•		•	•	ES-2S-24-L	ES-3S-24-L					
			•	•	•	ES-2S-12-H	ES-3S-12-H					
		•	•	•	ES-2S-24-H	ES-3S-24-H						
 Top Pin Connector	•			•	•	ES-2T-12	ES-3T-12					
	•			•	•	ES-2T-24	ET-3T-24					
		•		•	•	ES-2T-12-L	ES-3T-12-L					
		•		•	•	ES-2T-24-L	ES-3T-24-L					
			•	•	•	ES-2T-12-H	ES-3T-12-H					
		•	•	•	ES-2T-24-H	ES-3T-24-H						
 Wire Leads Side (Radial)	•			•	•	ES-2W-12	ES-3W-12					
	•			•	•	ES-2W-24	ES-3W-24					
		•		•	•	ES-2W-12-L	ES-3W-12-L					
		•		•	•	ES-2W-24-L	ES-3W-24-L					
			•	•	•	ES-2W-12-H	ES-3W-12-H					
		•	•	•	ES-2W-24-H	ES-3W-24-H						
 Board Mount	•			•	•	ES-2B-12	ES-3B-12					
	•			•	•	ES-2B-24	ES-3B-24					
		•		•	•	ES-2B-12-L	ES-3B-12-L					
		•		•	•	ES-2B-24-L	ES-3B-24-L					
			•	•	•	ES-2B-12-H	ES-3B-12-H					
		•	•	•	ES-2B-24-H	ES-3B-24-H						

Medium: Clean, dry air (40 micron filter)

Power Consumption: 1 watt at rated voltage

Temperature Range: 32 to 150°F

Response: 5 to 10 milliseconds at max rated pressure

Operating Range: 90 to 120% of rated voltage

Ports: Inlet and outlet through manifold; 3-way exhaust through top of valve (3-way only)



Valve Series	Standard
Standard	(blank)

Pressure Range	Suffix	Air Flow
28" Hg Vac. to 105 psig	(blank)	0.6 scfm @ 100 psig
28" Hg Vac. to 50 psig	-L	0.5 scfm @ 50 psig
28" Hg Vac. to 25 psig	-H	0.45 scfm @ 25 psig

See page 182 for flow charts.

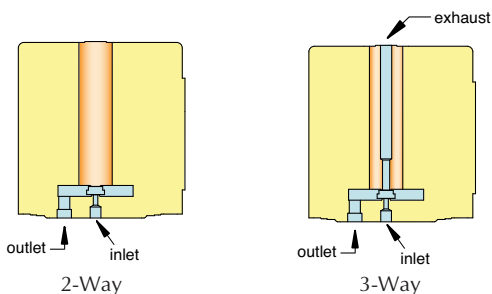

ESO SERIES 3-WAY FULLY-PORTED VALVES

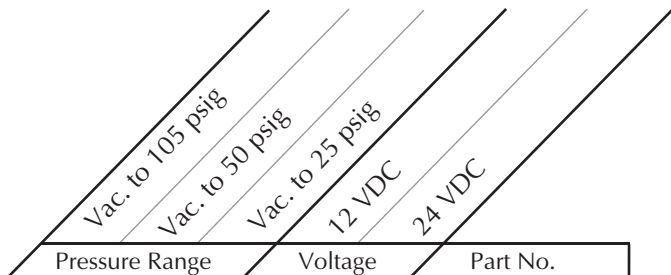
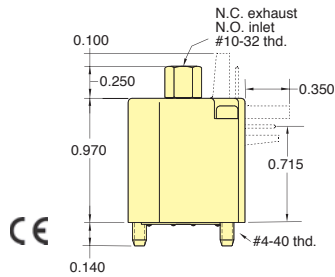

		Pressure Range			Voltage		Part No.
<p>Side Pin Connector</p>	•			•		ESO-3S-12*	
	•			•		ESO-3S-24*	
		•		•		ESO-3S-12-L*	
		•		•		ESO-3S-24-L*	
			•	•		ESO-3S-12-H*	
			•	•		ESO-3S-24-H*	
<p>Top Pin Connector</p>	•			•		ESO-3T-12*	
	•			•		ETO-3T-24*	
		•		•		ESO-3T-12-L*	
		•		•		ESO-3T-24-L*	
			•	•		ESO-3T-12-H*	
			•	•		ESO-3T-24-H*	
<p>Wire Leads Side (Radial)</p>	•			•		ESO-3W-12*	
	•			•		ESO-3W-24*	
		•		•		ESO-3W-12-L*	
		•		•		ESO-3W-24-L*	
			•	•		ESO-3W-12-H*	
			•	•		ESO-3W-24-H*	
<p>Board Mount</p>	•			•		ESO-3B-12*	
	•			•		ESO-3B-24*	
		•		•		ESO-3B-12-L*	
		•		•		ESO-3B-24-L*	
			•	•		ESO-3B-12-H*	
			•	•		ESO-3B-24-H*	

Top Port Options (below)

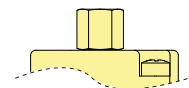

#10-32 (M5)
(standard)

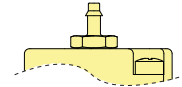

1/16" I.D. Hose Barb
(option "-1")

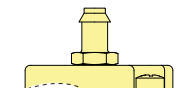

1/8" I.D. Hose Barb
(option "-2")

Medium: Clean, dry air (40 micron filter)

Power Consumption: 1 watt at rated voltage

Temperature Range: 32 to 150°F

Response: 5 to 10 milliseconds at max rated pressure

Operating Range: 90 to 120% of rated voltage

Ports: Normally-Closed: Inlet and outlet through manifold; exhaust through top of valve (#10-32)

Normally-Open: Exhaust and outlet through manifold; inlet through top of valve (#10-32)



Valve Series	Standard
Standard	(blank)
Options (*) (add to end of Part No.)	
#10-32 Female	(blank)
1/16" I.D. Hose Barb	-1
1/8" I.D. Hose Barb	-2

Pressure Range	Suffix	Air Flow
28" Hg Vac. to 105 psig	(blank)	0.6 scfm @ 100 psig
28" Hg Vac. to 50 psig	-L	0.5 scfm @ 50 psig
28" Hg Vac. to 25 psig	-H	0.45 scfm @ 25 psig

See page 182 for flow charts.

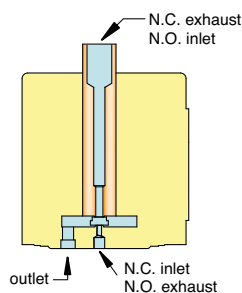

For Cable and Connectors, see Page 200.



ES & ESO SERIES VALVES MANIFOLDS

Single-Sided Dual Mount Manifold

Part No.	Description
26081-□	Single-Sided Manifold

Suffix	Valves	L	M1	M2
-4	4	4.375"	2.875"	4.000"
-6	6	6.125"	4.625"	5.750"
-8	8	7.875"	6.375"	7.500"

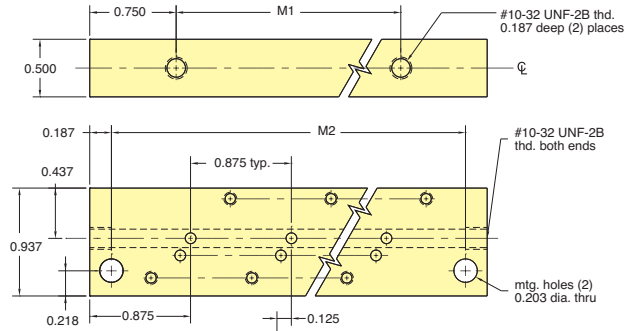

Double-Sided Dual Mount Manifold

Part No.	Description
26082-□	Double-Sided Manifold

Suffix	Valves	L	M1	M2
-8	8	4.375	2.875	4.000
-12	12	6.125	4.625	5.750
-16	16	7.875	6.375	7.500

* ESM-CP plate is to cover individual unused manifold station.

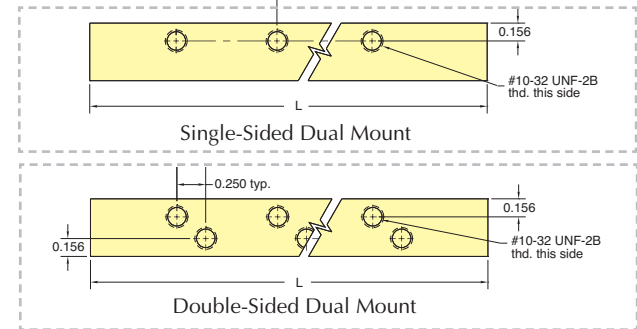

Single-Sided Rear Mount Manifold

Part No.	Description
26083-□	Single-Sided Manifold

Suffix	Valves	L	M
-4	4	3.500	2.875
-6	6	5.250	4.625
-8	8	7.000	6.375

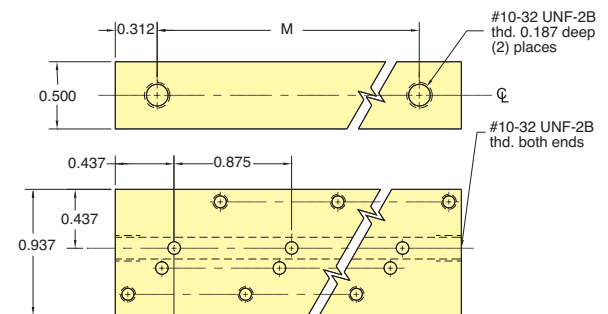

Double-Sided Rear Mount Manifold

Part No.	Description
26084-□	Double-Sided Manifold

Suffix	Valves	L	M
-8	8	3.500	2.875
-12	12	5.250	4.625
-16	16	7.000	6.375

* ESM-CP cover plate is available for one manifold station.

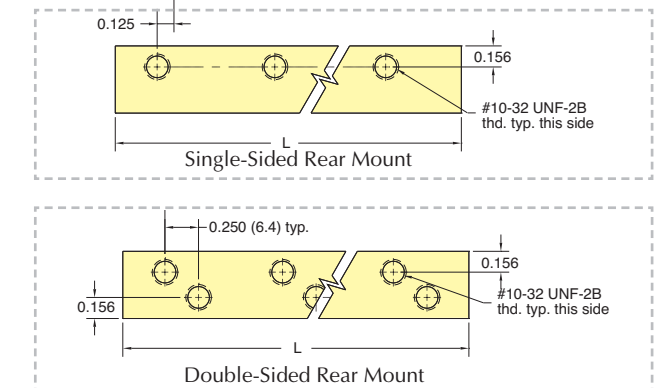

ES & ESO SERIES VALVES SINGLE MANIFOLDS



Single-Station Side Port Manifold

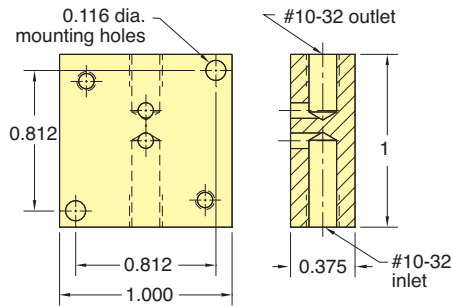

Part No. **Description**
26090-1 Side Port Manifold

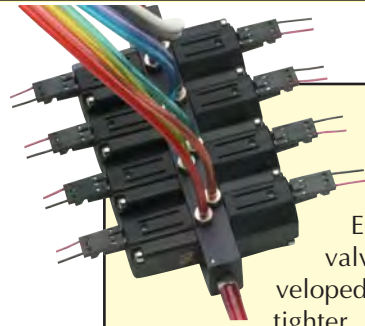

The ES/ESO series valve was developed to fit into tighter physical envelopes. By reducing the size of the base as well as the size of the coil, a considerable volume savings was achieved.

Single-Station Bottom Port Manifold

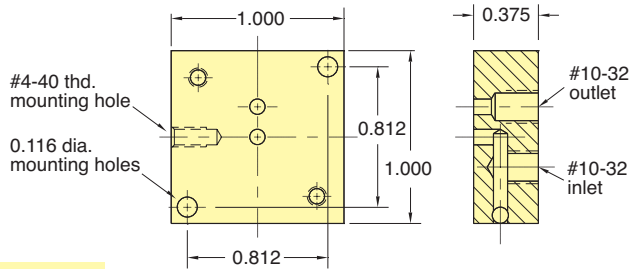

Part No. **Description**
26090-2 Bottom Port Manifold

As in the case of the EV/EVO product, the ES/ESO uses the single moving part design proven many times in the EV/ET/EC series valves. Of course, given the reduced size of the coil the power to operate increases to 1 watt.

Dual-Station Manifold

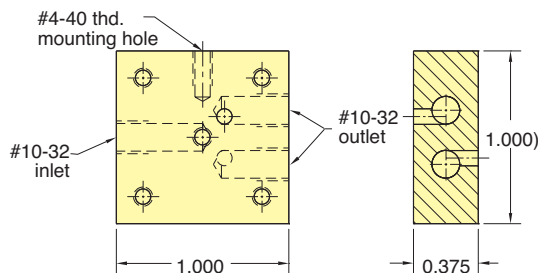

Part No. **Description**
26090-3 Dual Station Manifold

Because of its reliability, the ES/ESO series valve is found in many of the same applications and industries as its predecessor, the EV/ET/EC. However, the smaller size finds it used more commonly in portable or mobile equipment. This makes the valve particularly applicable in home healthcare applications.

TE Connectivity #5-103956-2 with 18" Wire Leads for ES/ESO Valves

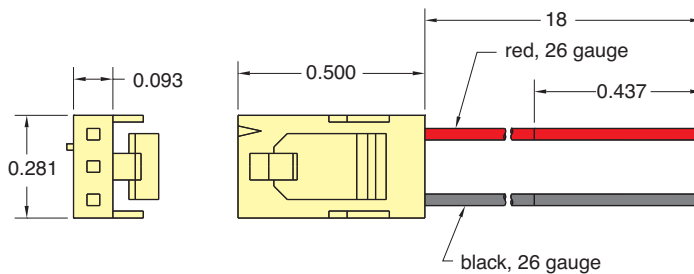

Lead Set Chart For ES Valve						
Part No.	Used On	Wire Colors			Lead Length	Wire Gauge
		Pin 1	Pin 2	Pin 3		
<u>C3-RXB18</u>	ES	red	~	black	18"	#26



NEW! 2-WAY ELECTRONIC VALVES, MANIFOLD & CARTRIDGE MOUNT

The Next Generation valve that is compact, quick and offers flows to 100 l/min!

Clippard Minimatic® DV, DT series electronic valves are precision-built 2-way control valves, utilizing a unique, patented valving principle. This powerful series was designed as the next generation of the well-known and trusted original EV line of Clippard “Mouse” valves. With a life of over a billion cycles, a solid, compact design, and extremely high flow rates, these valves are suitable for many applications across numerous diverse industries. A variety of voltage, connector and mounting options are available.

- Industry standard for leak-free operation
- Design flexibility and fast response
- Designed to accommodate large flows with more stroke
- Robust stainless steel “Spider”



Fast! High Flow! Economical!

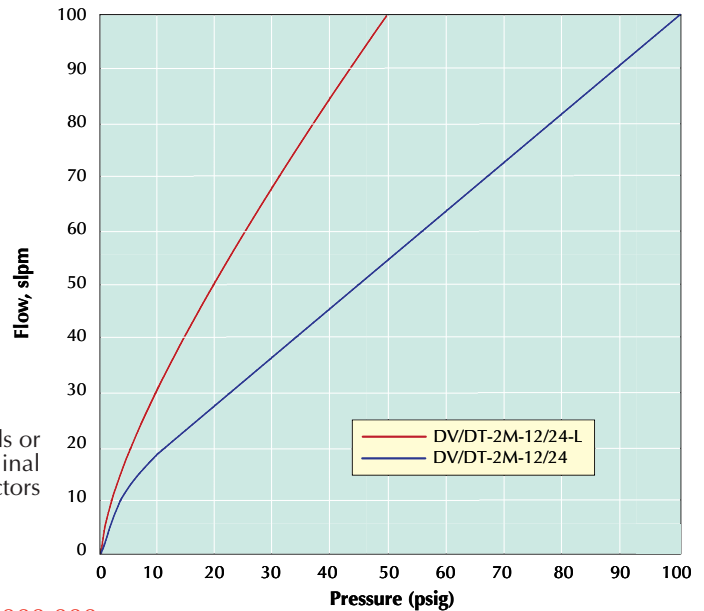
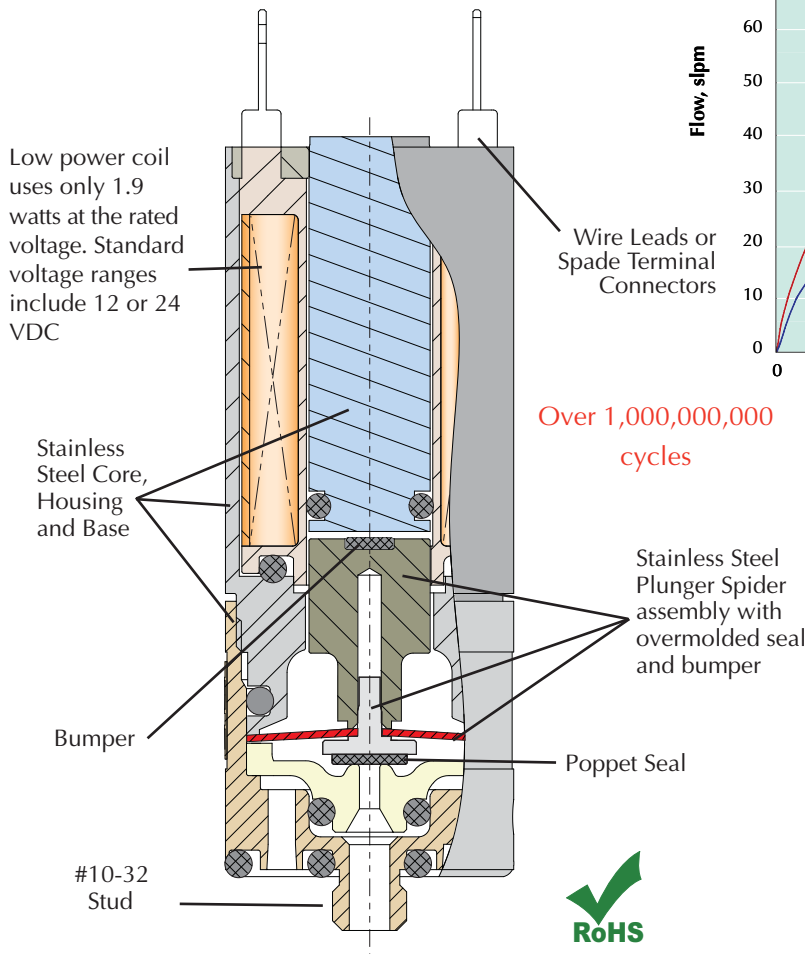

Features

- Bidirectional flow
- Fast response
- Low heat rise/low power
- Small package
- Single moving part-low friction and wear
- Two orifice sizes
- Two connection styles
- Two mounting types

NEW! 2-WAY ELECTRONIC VALVES, MANIFOLD & CARTRIDGE MOUNT



Easy Mounting

The DT/DV series electronic valves are available with two mounting options. Manifold models are equipped with a bottom stud, 5/32" long with #10-32 thread, which fits Clippard standard and special manifolds, accessory valves and subplates. Spanner holes in the valve body permit tightening.

Cartridge models fit into a 3/4" and 5/16" bore.



Multi-Station Manifolds

Material: Black anodized aluminum.

Ports: 1/8" NPT

Part No.	Description
15781-2	2-Station Manifold
15781-4	4-Station Manifold

Manifold Mount

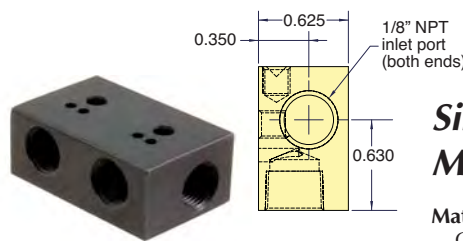

Single-Station Manifolds

Material: ENP brass standard. Others materials available, consult factory.

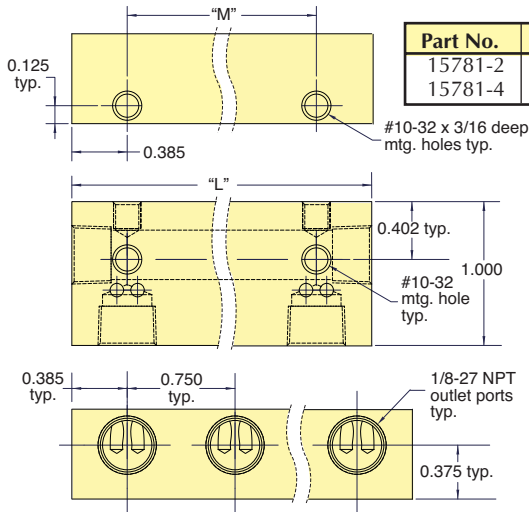

Part No.	Stations	Length "L"	Length "M"
15781-2	2	1.52	0.75
15781-4	4	1.74	2.25

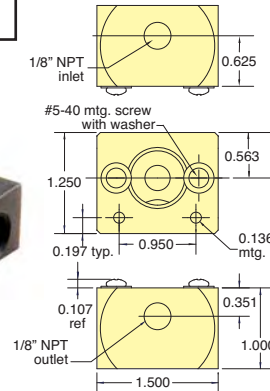

Cartridge Style

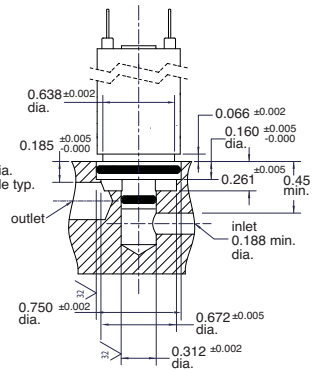

Part No.	Description
15492-1	Single-Station Cartridge Manifold

NEW! EFB Series Fill & Bleed Circuits



These compact Fill & Bleed circuits are a combination of electronic valves and manifolds used to inflate and vent or release pressure in a controlled system. These circuits are primarily used in applications where a particular pressure, firmness, or position can be controlled with the addition or venting of pressure.

[See Page 210.](#)



Manifold Mount

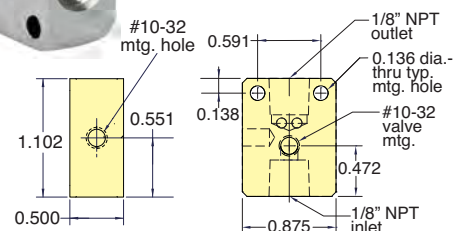

Part No.	Description
15490-5	Single-Station Manifold Mount



NEW! 2-WAY ELECTRONIC VALVES, MANIFOLD & CARTRIDGE MOUNT

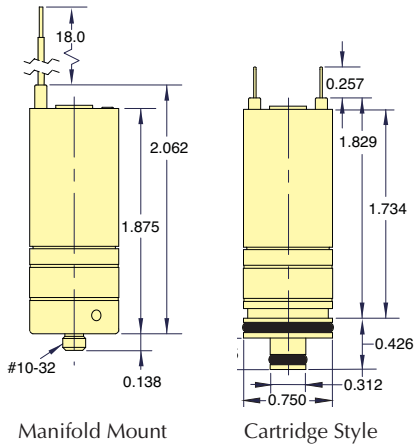

		Pressure		Voltage		Part No.	
		Vac. to 100 psig		Vac. to 50 psig		Manifold Mount	Cartridge Mount
				12 VDC	24 VDC		
	 Spade Terminals	•		•		DT-2M-12	DT-2C-12
		•		•	•	DT-2M-24	DT-2C-24
	 Wire Leads Top (Axial)	•		•		DV-2M-12	DV-2C-12
		•		•	•	DV-2M-24	DV-2C-24
			•		•	DV-2M-12-L	DV-2C-12-L
			•		•	DV-2M-24-L	DV-2C-24-L

Medium: Air or Compatible Gases (40 micron filter)

Air Flow: Standard: 100 l/min @ 100 psig;
 "-L" Option: 100 l/min @ 50 psig

Pressure Range: Standard: Vac. to 100 psig
 "-L" Option: Vac. to 50 psig

Power Consumption: 1.9 watts

Ports: #10-32 (on manifold mount valve)

Temperature Range @ Nominal Voltage: 32 to 130°F

Response: 10 to 15 milliseconds*

Electrical Connection: Spade Terminals or Wire Leads

Operating Range: 95 to 125% of rated voltage

Voltage: 12 or 24 VDC

Mounting: Manifold or Cartridge Style (inserts into a 3/4" bore)

Wetted Materials: PPS, Stainless Steel***

Seal Material: Nitrile standard. Silicone, FKM and EPDM optional**

* May vary depending on media. Consult factory for special requirements

** Other materials available for special design/project requirements. Consult factory.



Valve Series	Standard	Non-Standard
Standard	(blank)	
Options (add to end of Part No.)		
FKM Seals	-V	
EPDM Seals		-E
Silicone Seals		-S

Example Part No:
[DV-2M-12-V](#)

See Page 202 for mounting options

Pressure Range	Suffix	Air Flow
28" Hg Vac. to 100 psig	(blank)	100 l/min @ 100 psig
28" Hg Vac. to 50 psig	-L	100 l/min @ 50 psig

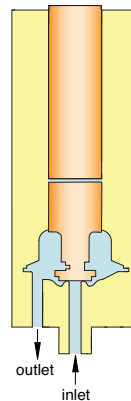

View additional information and useful videos



EVP SERIES PROPORTIONAL CONTROL VALVES



The EVP series Proportional Control Valves combine the features of the existing EV series valve - long life, low power, and Clippard's reputation for high quality components - with the additional capability for proportional control.

The EVP series valve provides air or gas flow control, and varies the output flow based on the current input to the solenoid. The consistent gain (see chart) of this valve provides a high degree of control for many applications.

Controllability and overall value are the main features of the EVP Proportional Valve series. The valve may be controlled using DC current, open or closed-loop control, and even PWM (Pulse Width Modulation) to cover a broad range of applications.

Features

- Flow proportional to input current
- Fast response
- Long life
- Small package
- Single moving part
 - low friction and wear
- Five orifice sizes
- Three connection styles
- Two mounting types

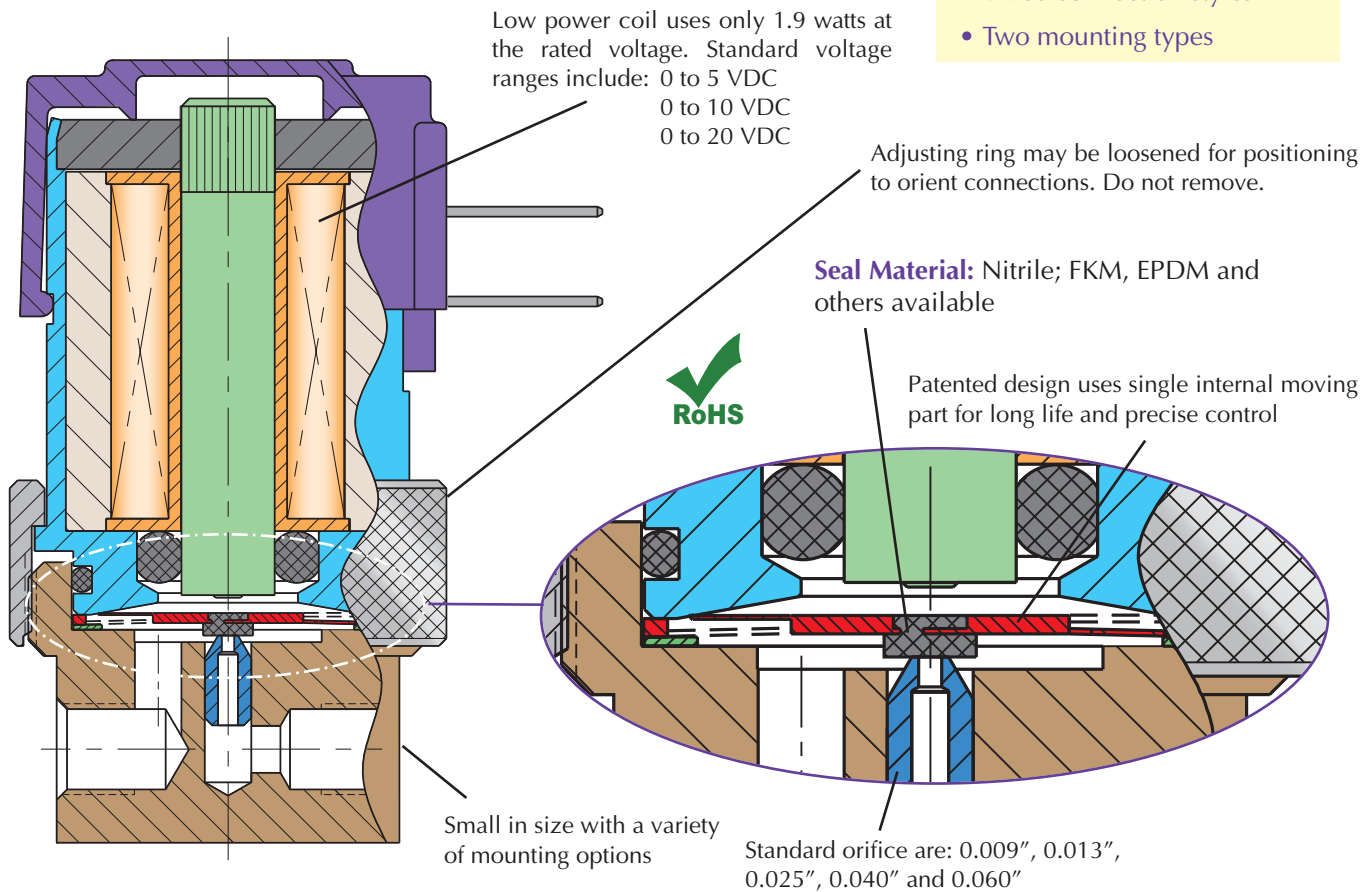

Designed For:

- Analytical Instruments
- Blood pressure monitoring
- Precise pressure control
- Patient Simulators
- Automotive
- Gas Controllers
- Mass Flow Control
- Gas Chromatography
- Respirators / Ventilators and many more...

Metric line available. Visit www.clippard.com



EVP SERIES 2-WAY PROPORTIONAL CONTROL VALVES



Based on Clippard's original spider design from 1973, the EVP's armature is the heart of the valve which provides precise flow control.

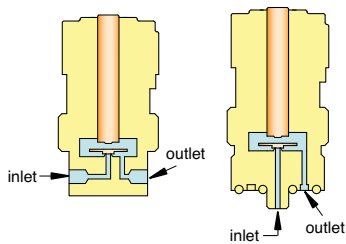

In-Line Mount Manifold Mount

- Medium:** Clean, dry air or inert gases
- Power Consumption:** 1.9 watts at 73°F, 2.3 watts max
- Temperature Range:** 32 to 120°F
- Ports:** #10-32 Female (in-line), #10-32 Male Stud (manifold). (see page 191 for manifold options)
- Seal Material:** Nitrile; FKM and EPDM. Others available.
- Maximum Hysteresis:** 10% of full current

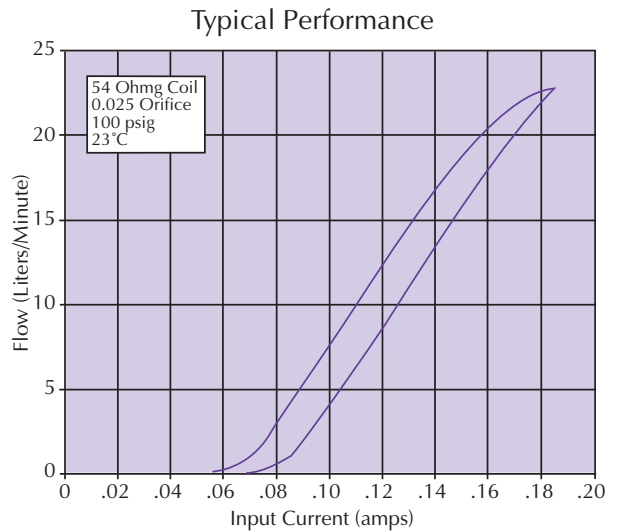

Operating Pressure

The EVP Proportional Valve can be calibrated for pressures less than the Maximum Pressure shown above. Lower pressures may be substituted in increments of 5 psig, and will be used for calibration. For pressures less than 5 psig, please consult Clippard Instrument Laboratory, Inc.

Note: Voltage, Orifice and Pressure are determined by the Part Number configured on the following page.

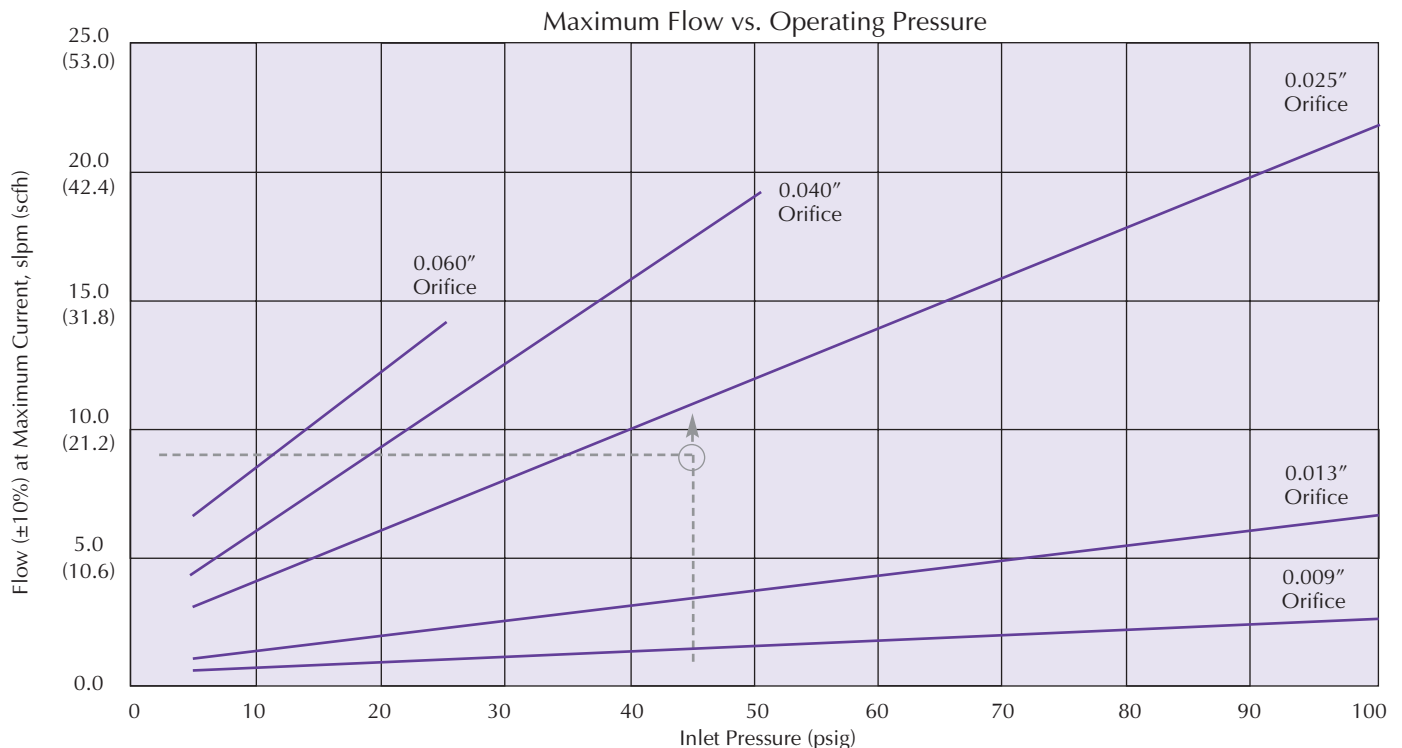

To determine the correct orifice required, locate the colored line immediately above the flow/pressure intersection. Example: 9 slpm required at 45 psig inlet. This example leads to a "-2545" valve (0.025" nozzle, 45 psig).

2-WAY PROPORTIONAL VALVES, IN-LINE & MANIFOLD MOUNT

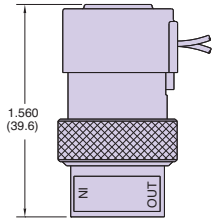

In-Line Mount

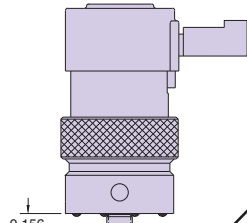

Manifold Mount



		Voltage			Base Part No.		Operating Range & Orifice
		5 VDC	10 VDC	20 VDC	In-Line Mount	Manifold Mount	
	0.025" Pin Connector	•			<u>EC-P-05-*</u>	<u>EC-PM-05-*</u>	In selecting your valve, you may have many variables to choose from. Each variable will affect others and this is a simple guide to provide assistance. To select the best valve for your application, focus on these three: Control Signal, Valve Orifice and Operating Pressure . <i>For Example</i> E V - P M - 2 0 - 2 5 8 5 Orifice Diameter Operating Pressure
		•	•		<u>EC-P-10-*</u>	<u>EC-PM-10-*</u>	
			•	•	<u>EC-P-20-*</u>	<u>EC-PM-20-*</u>	
	Spade Terminals	•			<u>ET-P-05-*</u>	<u>ET-PM-05-*</u>	
		•	•		<u>ET-P-10-*</u>	<u>ET-PM-10-*</u>	
			•	•	<u>ET-P-20-*</u>	<u>ET-PM-20-*</u>	
	Wire Leads Side (Radial)	•			<u>EV-P-05-*</u>	<u>EV-PM-05-*</u>	
		•	•		<u>EV-P-10-*</u>	<u>EV-PM-10-*</u>	
			•	•	<u>EV-P-20-*</u>	<u>EV-PM-20-*</u>	

* Consult factory for availability of non-standard voltages and other options

Although voltage is an important issue, the **current** is somewhat more **important**: It is very important to specify and use a calibrated valve that matches your application. Be sure to use a valve set to your operating pressure to assure you have an overall good performing valve for your exact requirements.

important to this valve. It works by having a change in **current** vary the magnetic field, which varies the travel or distance the valve is opening.

Control Signal

Nominal Voltage Range @ 73°F (VDC)	Input Current Range (amps)	Coil Resistance @ 73°F (ohms)	Max. Voltage Required (VDC)
0 to 5	0 to 0.370	13.5	6.2
0 to 10	0 to 0.185	54	12.4
0 to 20	0 to 0.092	218	24.8

Do not exceed input current range.

The EVP Valve can be calibrated for pressures less than the maximum shown above. Lower pressures may be substituted in increments of **5 psig**, and will be used for calibration. The pressures shown above are standard options. For pressures less than 5 psig or greater than the Maximum Pressure listed, please consult factory.

Standard Valve Orifices & Flow

Orifice	Max Flow (l/min)*	Part No. Code	Max. Pressure (psig)
0.009"	2.7 ±10%	09	100 psig
0.013"	6.7 ±10%	13	100 psig
0.025"	22.0 ±10%	25	100 psig
0.040"	18.7 ±10%	40	50 psig
0.060"	14.0 ±10%	60	25 psig

* Measured at Maximum Pressure

Base Part No. plus

Ports:
Blank #10-32

See [Page 205](#) for flow chart/selection

Orifice:

- 09 - 0.009" dia.
- 13 - 0.013" dia.
- 25 - 0.025" dia.
- 40* - 0.040" dia.
- 60* - 0.060" dia.

* See Max. Pressure above

Maximum Pressure (specify Operating Pressure):

- - 5 to 99 psig
- AO - 100 psig

Options:
Blank - Nitrile seals (standard)
E - EPDM seals
V - FKM seals

[View additional valve selection tips](#)



EVPD PROPORTIONAL VALVE DRIVER

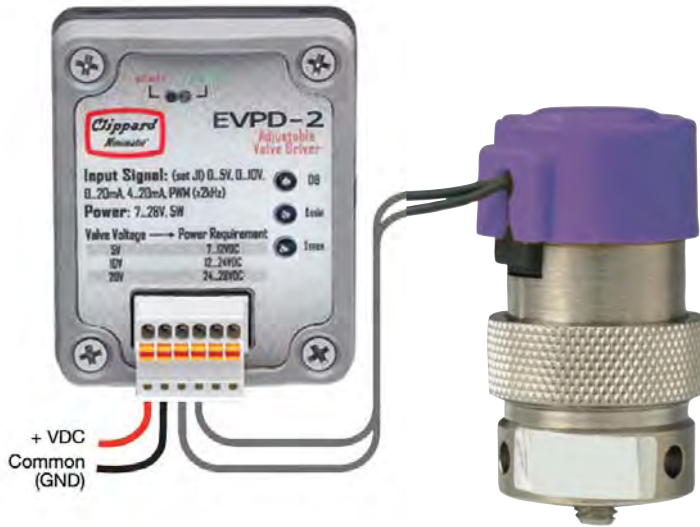

Plug-and-Play Control for Proportional Valves

The EVPD Proportional Valve Driver fast-tracks valve-control applications. This product is ideal for laboratories and OEM product development, and can be customized to fit OEM applications including control parameters. The EVPD produces driver current for Clippard's EVP series valves proportional to input control signals.

Power Requirement: 7 to 28 VDC @ 5 Watt (see chart)

Input Impedance: 200 kΩ

Command Set-Point Signal Type: Selectable: 0 to 5 VDC, 0 to 10 VDC, 0 to 20 mA, 4 to 20 mA, PWM @ ≥ 2 kHz duty cycle

Adjustments: Minimum Drive Current, Maximum Drive Current, Command Deadband

LED Indicators: Power; Activity Status & Faults

Output: 0 to 0.4 A (selectable range)

Temperature Range: 0° to 155°F

Size: Open card: 1.5" x 1.3" x 0.4" unmounted; Enclosed: 2.2" x 1.8" x 0.7" excluding DIN clip



For further information, visit www.clippard.com/evpd

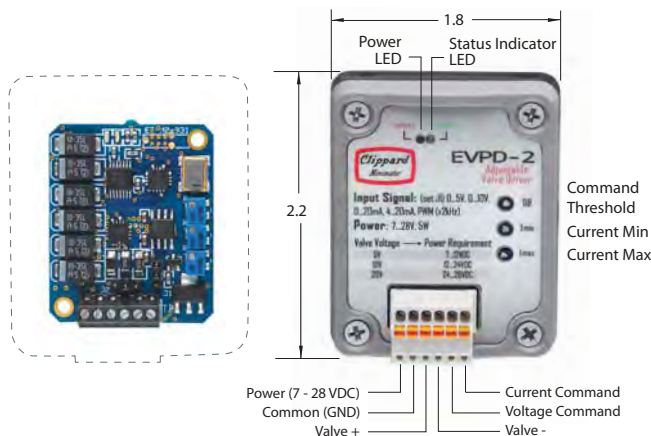

Features

- Plug-and-play interface between Clippard's EVP series valves and PLCs or other controls
- Linearized valve response right "out of the box"
- Three selectable valve output ranges
- Five signal inputs to choose from
- Easy integration with existing machine controls
- User-adjustable parameters
- Automatic Temperature Compensation to maintain constant current
- Two configuration options: stand-alone PCB or enclosed in housing
- Compact size.

Power Requirements

Power input requirements are specified as supply voltage ranges for each EVP valve. Supplying voltages outside of these ranges may result in valve malfunctioning. Power requirements are determined by the valve voltage specification.

EVP Valve Type	Input Voltage Range	EVPD Max Output*
0 to 5 VDC	7 to 12 VDC	400 mA
0 to 10 VDC	12 to 28 VDC	200 mA
0 to 20 VDC	14 to 28 VDC	100 mA

* See EVP Valve Current Requirements

Part No.	Description
<u>EVPD-2</u>	EVPD Driver Assembly in Enclosure
<u>EVPD-1</u>	EVPD Driver Board
<u>EVPD-2DIN</u>	DIN Rail Mounting Clip (shown at right) with Screws

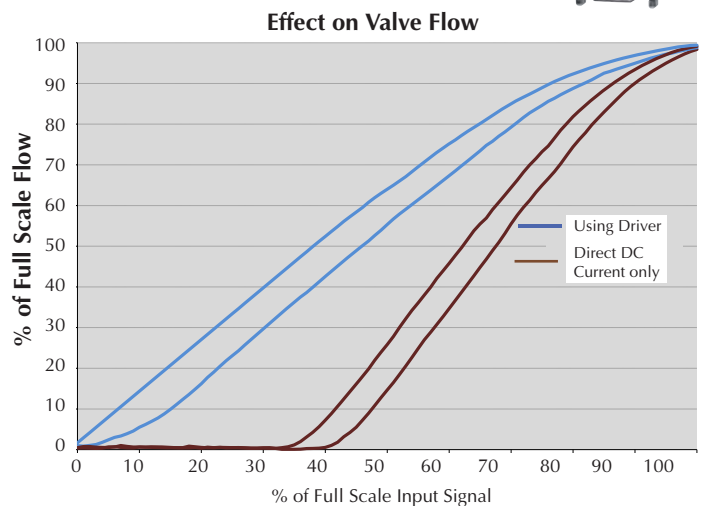

Figure 1: Effect of Driver Output on EVP Flow

EXPANDED! 2-WAY STEPPER-CONTROLLED PROPORTIONAL VALVES



Features

- <2% hysteresis
- Excellent Linearity — <2.5% of full-scale
- 2 ms reaction time
- Millions of cycles
- Holds position for power savings or at loss of power

Stepper-controlled linear actuator with acme lead screw

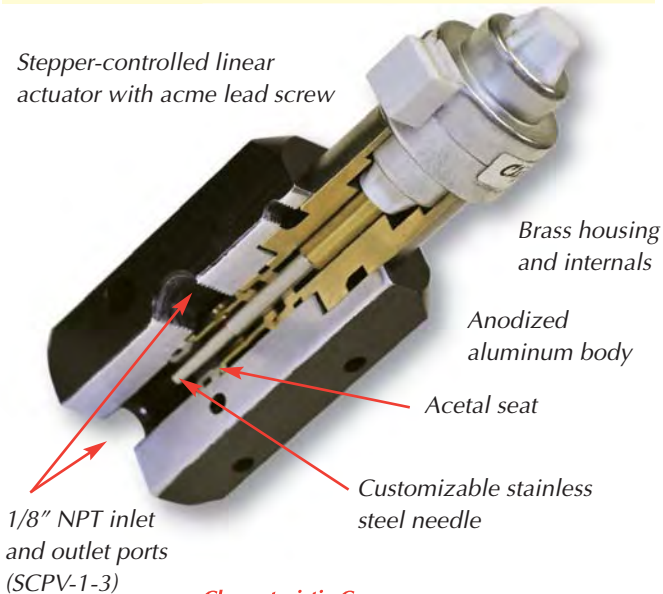

Characteristic Curve

Flow Rate for SCPV-1-3 @ 100 psig

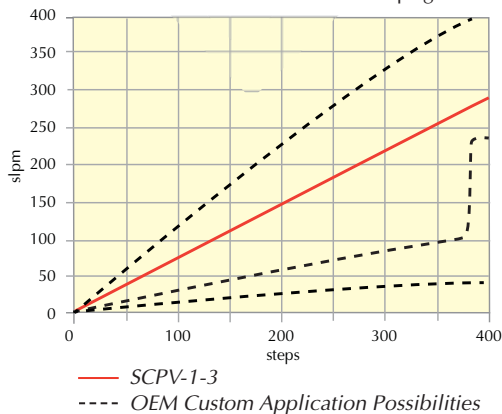

Utilizing the industry's most robust and powerful linear actuator, the high flow stepper-controlled proportional valve outperforms the competition in performance and durability.

This valve is ideal in critical applications such as gas delivery, medical, analytical, and industrial automation requiring high resolution, high flow, and low hysteresis. In addition, the unique design allows for custom flow profiles when required.

Medium: Air and compatible gases

Typical Cycle Time for Full Travel: 0.95 seconds at 100% duty cycle; 0.55 seconds at 25% duty cycle (full open to full close or full close to full open)

Wetted Material: Stainless steel, aluminum, brass, Acetal and FKM*

Pressure Range: Vac to 100 psig*

Flow Range: 0 to 280 slpm (special configurations over 500 slpm available, consult factory)*

Flow Resolution: 0.7 slpm per step

Position Resolution: 0.001" per step

Temperature Range: 32 to 184°F

Driver: Bipolar chopper drive required

Needle: 3.5°

Supply Voltage to Motor: 5 VDC

Response Time: 0.95 sec. fully-open to fully-closed

Mounting: In-line, manifold or cartridge

Power Consumption: 3.85 watts nominal only during adjustment. Zero power consumption to maintain position.

Seals: FKM standard. Others available.

Option: Rubber seat (add "-R" suffix)

* This product is highly modifiable for OEM applications including alternate body materials, flow profiles, cartridge styles, manifold mounting, etc. Please consult factory.

Clippard has successfully produced special configurations of the SCPV with flows over 700 slpm at 100 psig. Please consult factory with your specific requirements.

Part No.	Description
SCPV-1-3	Proportional Valve, In-Line
SCPV-1-3M	Proportional Valve, Manifold
SCPV-1-3C	Proportional Valve, Cartridge



For further information, visit www.clippard.com/scpv





EXPANDED! 2-WAY STEPPER-CONTROLLED PROPORTIONAL VALVES

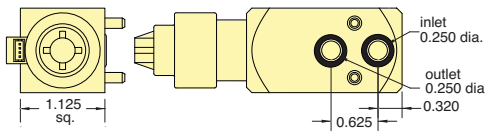
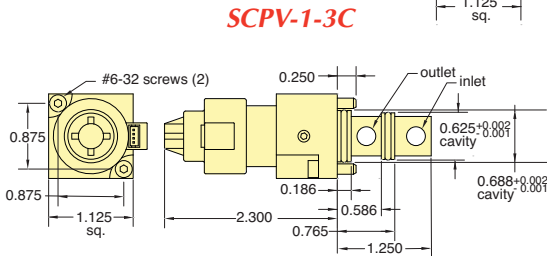
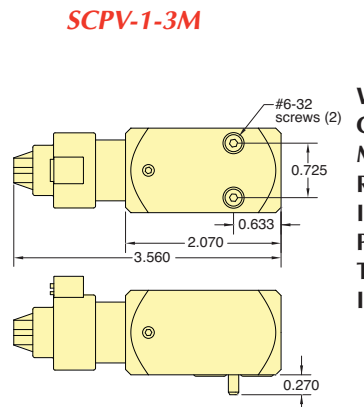
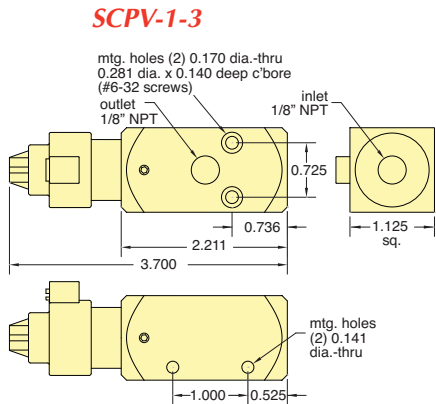

For helpful information and video, visit www.clippard.com/scpv

Linear Actuator Characteristics

Wiring:	Bipolar
Current/Phase:	385 mA
Motor Voltage:	5 VDC
Resistance/Phase:	13 ohms
Inductance/Phase:	8.08 mH
Power Consumption:	3.85 Watts
Temperature Rise:	135°F
Insulation Resistance:	20M ohms

Maximum Step Pulse Frequency vs. Operating Pressure

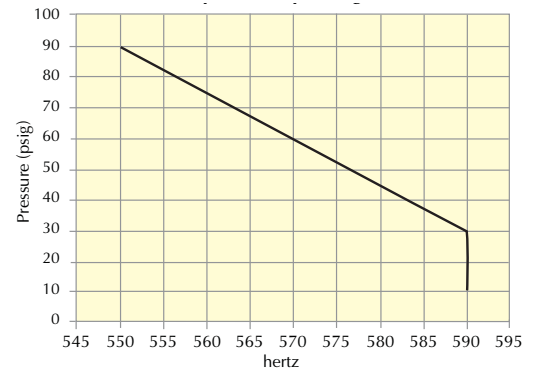

Control Data

A **Bipolar Chopper Drive** (not included) is a power-efficient method of using current to drive a stepping motor to obtain high stepping rates. The chopper gets its name from the technique of rapidly turning the output voltage on and off (chopping) to control motor current.

Stepper motors require some external electrical components in order to operate. These components typically include a power supply, logic sequencer switching components, and a clock pulse source to determine the step rate. Many commercially available drives have integrated these components into a complete package. See www.clippard.com/scpv for more information.

Wiring Harness (included)

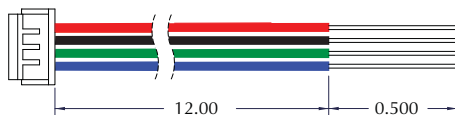

Pin	Color	Pin	Color
1	Red (A+)	3	Green (B-)
2	Black (A-)	4	Blue (B+)

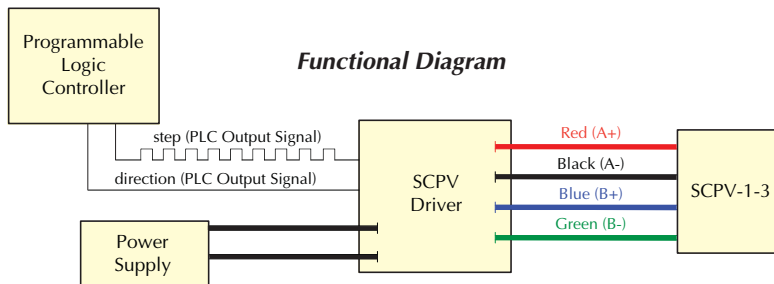

Potential Applications



- Medical/Analytical/Industrial Gas Mixing
- Anesthesia Equipment
- Precision Flow Control
- Cuff/Bladder Pressure Control
- Process Flow Control
- Variable Speed Control
- Automation of Needle Valve



NEW! EFB ELECTRONIC FILL & BLEED CIRCUITS



A Fill and Bleed Circuit is a combination of pneumatic valve components used to inflate a volume or apparatus in one controllable function, and to release or vent pressure in a second controllable function.

In-Line Mount	Flow	Max. Pressure			Voltage		Part No.	Valve
		100 psig	50 psig	25 psig	12 VDC	24 VDC		
	100 l/min @ 100 psig	•			•		EFB-1DV-12	DV-2M-12
		•			•	•	EFB-1DV-24	DV-2M-24
	80 l/min @ 50 psig		•		•		EFB-1DV-12-L	DV-2M-12-L
			•		•	•	EFB-1DV-24-L	DV-2M-24-L
	13 l/min @ 25 psig			•	•		EFB-1EM-12-H	EM-2-12-H
				•	•	•	EFB-1EM-24-H	EM-2-24-H
Manifold Mount 	17 l/min @ 100 psig	•			•		EFB-2EV-12	EV-2M-12
		•			•	•	EFB-2EV-24	EV-2M-24
	14 l/min @ 50 psig		•		•		EFB-2EV-12-L	EV-2M-12-L
			•		•	•	EFB-2EV-24-L	EV-2M-24-L
	13 l/min @ 25 psig			•	•		EFB-2EV-12-H	EV-2M-12-H
				•	•	•	EFB-2EV-24-H	EV-2M-24-H
	100 l/min @ 100 psig	•			•		EFB-2DV-12	DV-2M-12
		•			•	•	EFB-2DV-24	DV-2M-24
	100 l/min @ 50 psig		•		•		EFB-2DV-12-L	DV-2M-12-L
			•		•	•	EFB-2DV-24-L	DV-2M-24-L

Manifold Material: Black Anodized Aluminum

- Extremely Fast Response
- Exceptionally Long Life
- Multiple Flow & Pressure Options
- Compact, Robust Design

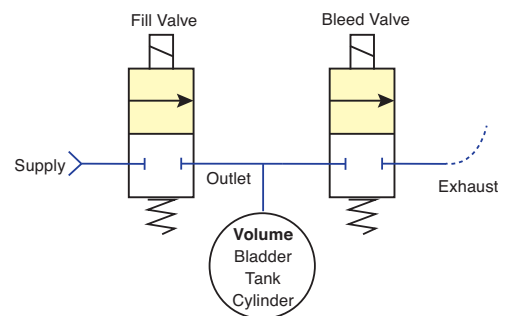

Metric line available. Visit www.clippard.com



NEW! EFB ELECTRONIC FILL & BLEED CIRCUITS

Manifold Only

Material: Black anodized aluminum



Part No.	Description
EFB-1M*	In-Line Manifold Only
EFB-2M**	Manifold Mount Manifold Only

- * Specify your own manifold mount DV, DT or EM valve when selecting the manifold only.
- ** Specify your own manifold mount DV, DT, EV or EM valve when selecting the manifold only.

See Pages 177 through 203

Circuit	"A"	"B"
EFB-1DV	4.874	
EFB-1EM	3.057	
EFB-2EV		2.310
EFB-2DV		2.812

In-Line Mount

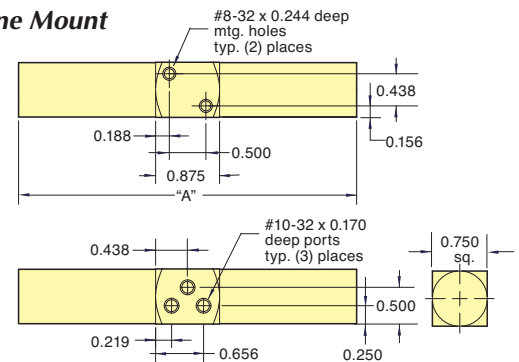

Manifold Mount

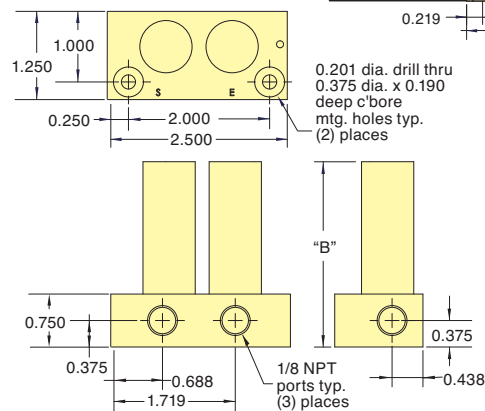

Three Typical Examples of Fill and Bleed Applications

Pressure **control systems** typically use a fill and bleed type circuit to add or subtract air in maintaining pressure. They can also be referred to as E/P or Electronic Pressure Control when feedback is provided to read the downstream or output pressure and looped back to tell a PLC or System to fill or bleed more pressure. These can be tremendously accurate depending on the speed and orifice of the valves used in the circuit and the accuracy of a pressure transducer.

Clippard EV valves are commonly used in these applications in analytical and instrumentation equipment, medical devices such as blood pressure cuffs, and pressure control industrial applications.



In **lumbar support applications**, pressure would be better defined as firmness, where a pneumatic fill and bleed circuit is controlling the air pressure in a flexible bladder built into a seat. Massage or therapy chairs use multiple bladders filling and bleeding pressure that changes the firmness in a sequential pattern massaging the user. These applications can be found in first-class airline seats, train seats, truck or mobile cabs where the operator is sitting for extended periods of time.



Position is based on the same principle when applying a fill and bleed circuit along with the basic cylinder formula of $PRESSURE \times AREA = FORCE$ and linear spring force. Using a single acting cylinder, the linear spring force on the cylinder needs to be overcome with a particular pressure in order to move. As the cylinder moves, the force required to push against the spring force changes, therefore varying the pressure can simply vary the position. For example, if a cylinder was used to move the position of a table up or down, a fill and bleed circuit can be applied to the bottom of the cylinder to adjust pressure, which in turn changes the position.

The components can be quite simple and robust, such as the FBV manual fill and bleed valves. Or, for integration with electronic controls, a combination of electronics valves can achieve very simple or more complex circuit for your fill and bleed applications.

NEW! EGV ELECTRONIC HIGH FLOW POPPET VALVES, 2-WAY & 3-WAY

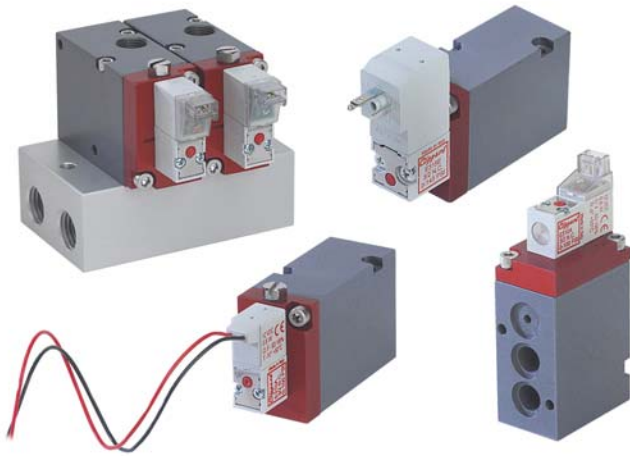

Clippard's EGV Series valves are an electronically-piloted version of the GV series valves (page 123), ideal for large flow, low leak applications. Available in 1/8" NPT ported and manifold mount, they utilize Clippard 10 mm or 15 mm valves, and offer numerous voltage and connection options. These 2-way and 3-way valves provide 10 times more flow than Clippard's MAV series and 2.5 times more flow than the MJV series! An externally piloted option is available for controlling lower pressures and medias.

- Small, compact, lightweight with high flow
- Large variety of control voltages and connections
- Proven poppet design
- Electroless nickel plated brass and hard coat anodized aluminum construction for long life and corrosion resistance



EGV-2/3 Series
(In-Line Connector shown)

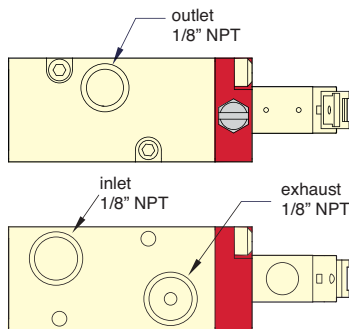
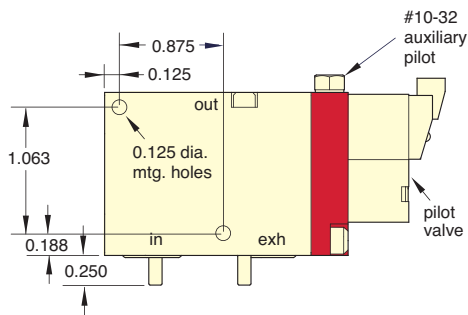

EGV-2M/3M Series
(In-Line Connector shown)

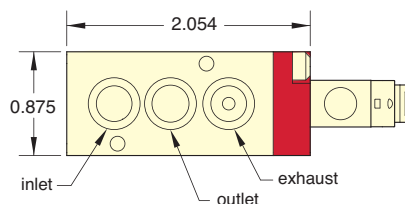
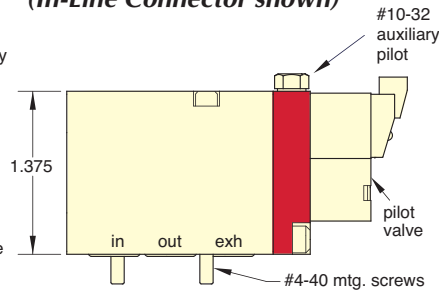

[View instructions on how to convert from internally to externally piloted valve](#)

Mounting Interface

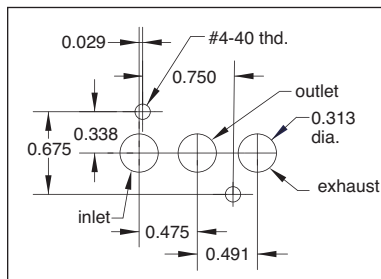
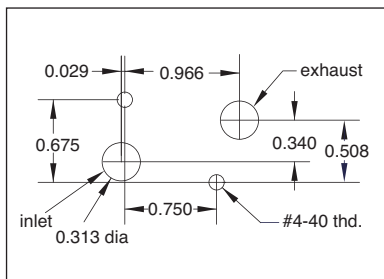

Metric line available. Visit www.clippard.com

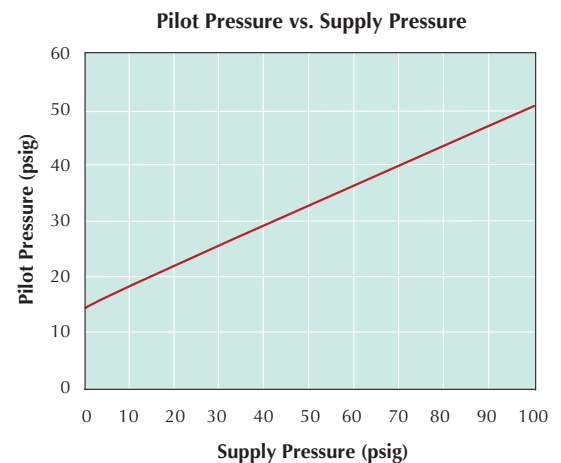
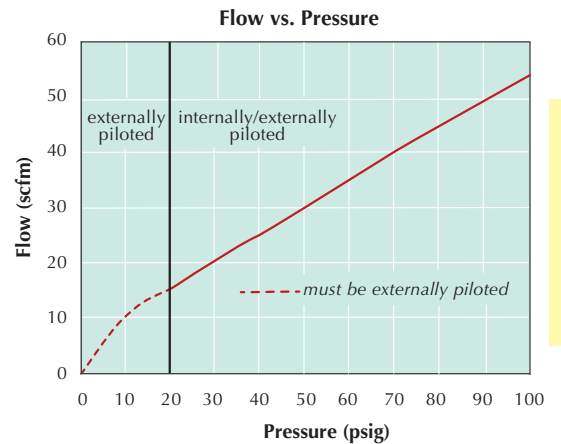



NEW! EGV ELECTRONIC HIGH FLOW POPPET VALVES, 2-WAY & 3-WAY

Specifications

Medium: Air*

Input Pressure: 150 psig max.

Air Flow: 30 scfm @ 50 psig; 53 scfm @ 100 psig

Temperature Range: 32 to 230°F

Ports: 1/8" NPT and manifold mount

Power Consumption: 0.6 or 2.5 watts

Mounting: NPT, side mounted or Manifold (come with mounting screws and seals)

Materials: Aluminum, Stainless Steel, Brass, Nylon

Voltage: 12 VDC, 24 VDC, 24 VAC, 110 VAC, 220 VAC

Seals: Nitrile, FKM optional (add suffix "-V" to Part No.)

* Other pressures and media are available with externally piloted versions. Contact Clippard for more information.



Electrical Connection Options

90° Connector



Connector ordered separately on page 224

DIN Connector



Form C DIN Connector ordered separately on page 224

In-Line Connector



Connector ordered separately on page 224

Wire Leads



Order Information

NPT Ported or Mount	Manifold Mount (only)**	Connector	12 VDC	24 VDC	24 VAC	110 VAC	220 VAC	Watt	Working Pressure
2-Way Valves									
EGV-2-E*	EGV-2M-E*	90° Connector	•	•				0.6	14.7 to 110 psig
EGV-2-L*	EGV-2M-L*	90° Connector with LED	•	•					
EGV-2-F*	EGV-2M-F*	In-Line Connector	•	•					
EGV-2-C*	EGV-2M-C*	In-Line Connector with LED	•	•					
EGV-2-W*	EGV-2M-W*	Wire Leads, 11.8"	•	•				2.5	0 to 150 psig
EGV2-D*	EGV-2M-D*	DIN Connector	•	•	•	•	•		
3-Way Valves									
EGV-3-E*	EGV-3M-E*	90° Connector	•	•				0.6	14.7 to 110 psig
EGV-3-L*	EGV-3M-L*	90° Connector with LED	•	•					
EGV-3-F*	EGV-3M-F*	In-Line Connector	•	•					
EGV-3-C*	EGV-3M-C*	In-Line Connector with LED	•	•					
EGV-3-W*	EGV-3M-W*	Wire Leads, 11.8"	•	•				2.5	0 to 150 psig
EGV-3-D*	EGV-3M-D*	DIN Connector	•	•	•	•	•		

* Add Voltage Choice to the end of each Base Part Number. "012" (12 VDC), "024" (24 VDC) "24A" (24 VAC), "110" (110 VAC) or "220" (220 VAC). Example: [EGV-2-E012](#)

** Designed for use with custom products and Value Added assemblies

Manifolds

- Clear anodized aluminum

Description	NPT Ported Styles	Manifold Mount Style
2-Station Manifold	EGVM-2	EGVMM-2
4-Station Manifold	EGVM-4	EGVMM-4

See Page 227 for Wire Connectors

Dimensions available at www.clippard.com

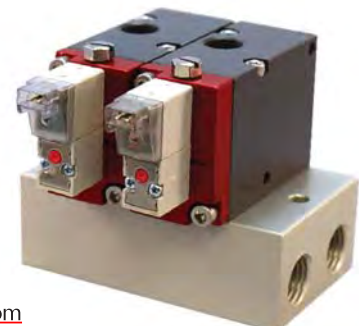

All of the benefits of Clippard quality and reliability are now available in these 10 mm and 15 mm valves. Offered in both Normally-Open or Normally-Closed models, these 2-way and 3-way valves are perfect for small areas where compact electronically-controlled pneumatics are needed.

This series has a high strength, engineered light-weight glass filled nylon body, along with stainless steel, copper and Nitrile, making it suitable for a broad range of applications. With exceptional life and reliability this is the perfect sub-miniature valve for tomorrow's needs in a wide variety of industries.

10 mm Standard Series

Direct operating valves well-suited for single- or multiple-valve mounting in small spaces.

See pages 215 - 217



15 mm Standard Series

Direct operating valves well-suited for single- or multiple-valve mounting in small spaces.

See pages 222 - 224



10 mm Latching Series

A short pulse of current shifts this valve which "latches" indefinitely; another pulse returns the valve.

See page 218



15 mm Latching Series

A short pulse of current shifts this valve which "latches" indefinitely; another pulse returns the valve.

See page 225



10 mm High Flow 2-Way Series

Specialty series for high flow applications.

See page 219



15 mm High Flow 2-Way Series

Specialty series for high flow applications.

See page 226



10 mm ISO 15218 Series

Conforms to ISO standard for mounting and port locations.

See page 220



All 10 mm and 15 mm valves are RoHS compliant.

Valve Material: Glass filled Nylon, Stainless Steel, Nitrile or FKM Elastomer

Electrical: The coil is constructed of copper wire and is insulated according to the class "F" standard. All circuitry and connections are protected from corrosion.

Weight: 10 mm Series: 0.4 oz.; 15 mm Series: 1.3 oz.

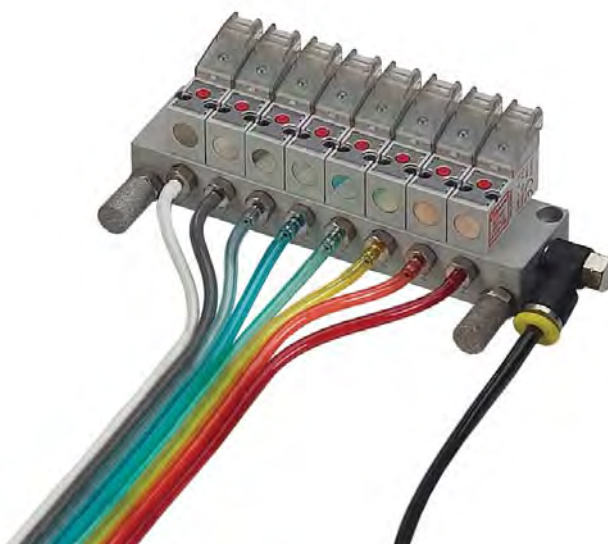



10 MM MINIATURE VALVES

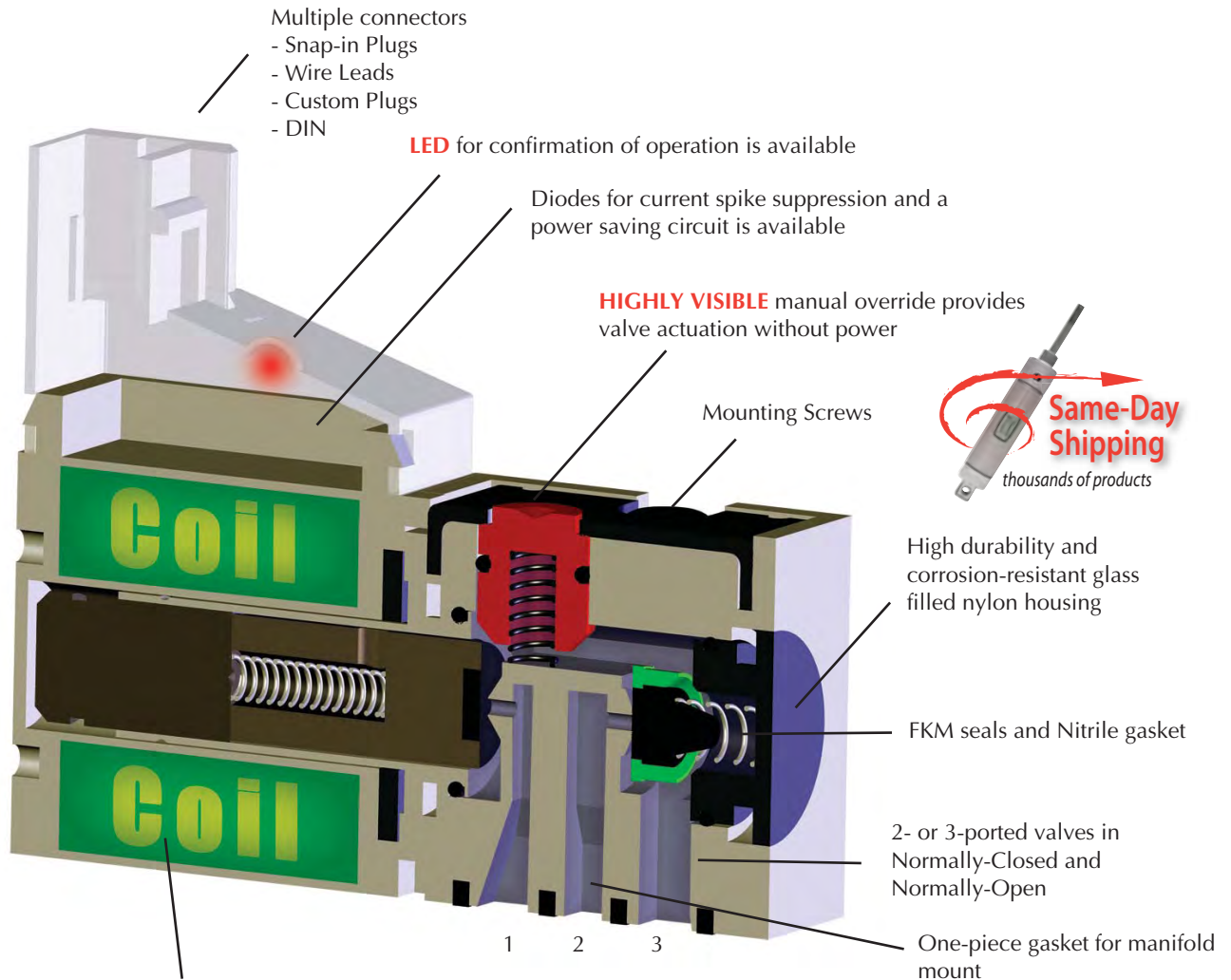

Encapsulated low wattage coils. Available in 12 VDC or 24 VDC. Special voltages available for OEMs.

Config.	1	2	3
N.C.	supply	exhaust	outlet
N.O.	exhaust	supply	outlet



Functional Schematics

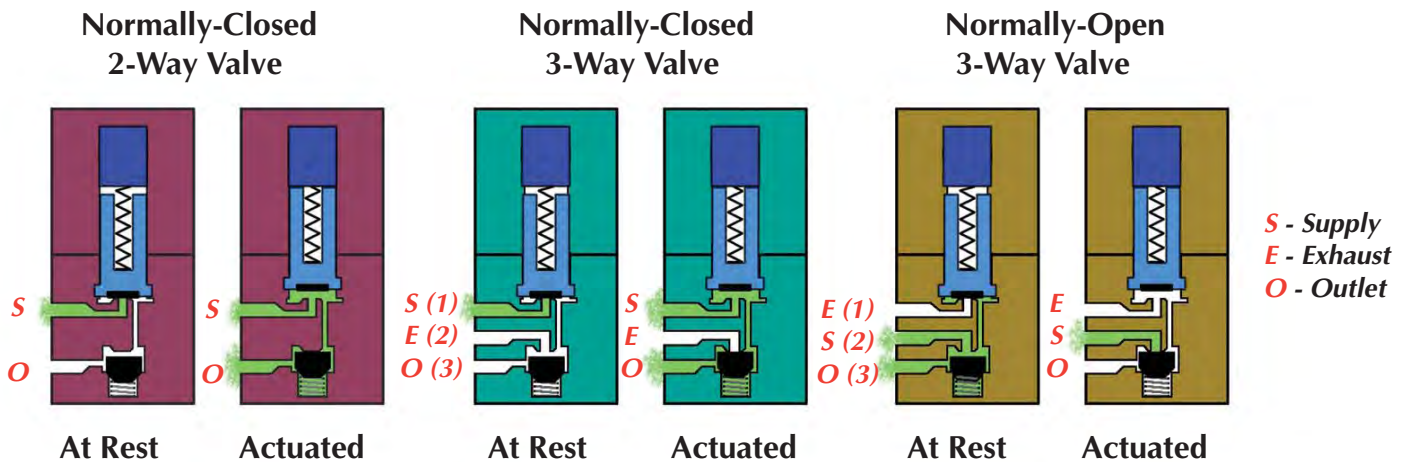



Specifications



Medium: Air, Gas or other Compatible Fluids

Working Pressure: See Chart below

Max. Flow Rate:
 0.020" Orifice: 14 l/min
 0.030" Orifice: 31.2 l/min

Exhaust Flow:
 0.020" Orifice: 22.7 l/min
 0.030" Orifice: 34 l/min

Response Time: 8 ms when energized; 10 ms when de-energized

Electrical: 12 VDC or 24 VDC

Voltage Tolerance: -5% to +10%

Power Consumption: 0.6 or 1.3 watts dependent on orifice size and pressure

Material: Stainless steel core and springs, nylon body, FKM dynamic seals, and Nitrile gasket and static seals.

Coil Insulation Class: F 311°F

Temperature Range: 23 to 122°F. When below 32°F, must use clean, dry air



Order Information

Type	Base No.	Connector	Orifice	Wattage	Working Pressure
2/2 Normally-Closed 	<u>E210A-1E*</u>	90° Connector	0.020"	0.6	14.7 to 110 psig
	<u>E210C-2E*</u>		0.030"	1.3	0 to 110 psig
	<u>E210A-1L*</u>	90° Connector with LED	0.020"	0.6	14.7 to 110 psig
	<u>E210C-2L*</u>		0.030"	1.3	0 to 110 psig
	<u>E210A-1F*</u>	In-Line Connector	0.020"	0.6	14.7 to 110 psig
	<u>E210C-2F*</u>		0.030"	1.3	0 to 110 psig
	<u>E210A-1C*</u>	In-Line Connector with LED	0.020"	0.6	14.7 to 110 psig
<u>E210C-2C*</u>	0.030"		1.3	0 to 110 psig	
<u>E210A-1W*</u>	Wire Leads, 11.8"	0.020"	0.6	14.7 to 110 psig	
<u>E210C-2W*</u>		0.030"	1.3	0 to 110 psig	
3/2 Normally-Closed 	<u>E310A-1E*</u>	90° Connector	0.020"	0.6	14.7 to 110 psig
	<u>E310C-2E*</u>		0.030"	1.3	0 to 110 psig
	<u>E310A-1L*</u>	90° Connector with LED	0.020"	0.6	14.7 to 110 psig
	<u>E310C-2L*</u>		0.030"	1.3	0 to 110 psig
	<u>E310A-1F*</u>	In-Line Connector	0.020"	0.6	14.7 to 110 psig
	<u>E310C-2F*</u>		0.030"	1.3	0 to 110 psig
	<u>E310A-1C*</u>	In-Line Connector with LED	0.020"	0.6	14.7 to 110 psig
<u>E310C-2C*</u>	0.030"		1.3	0 to 110 psig	
<u>E310A-1W*</u>	Wire Leads, 11.8"	0.020"	0.6	14.7 to 110 psig	
<u>E310C-2W*</u>		0.030"	1.3	0 to 110 psig	
3/2 Normally-Open 	<u>E3O10A-1E*</u>	90° Connector	0.020"	0.6	14.7 to 70 psig
	<u>E3O10C-2E*</u>		0.030"	1.3	0 to 110 psig
	<u>E3O10A-1L*</u>	90° Connector with LED	0.020"	0.6	14.7 to 70 psig
	<u>E3O10C-2L*</u>		0.030"	1.3	0 to 110 psig
	<u>E3O10A-1F*</u>	In-Line Connector	0.020"	0.6	14.7 to 70 psig
	<u>E3O10C-2F*</u>		0.030"	1.3	0 to 110 psig
	<u>E3O10A-1C*</u>	In-Line Connector with LED	0.020"	0.6	14.7 to 70 psig
<u>E3O10C-2C*</u>	0.030"		1.3	0 to 110 psig	
<u>E3O10A-1W*</u>	Wire Leads, 11.8"	0.020"	0.6	14.7 to 70 psig	
<u>E3O10C-2W*</u>		0.030"	1.3	0 to 110 psig	

* Add Voltage Choice to the end of each Base Part Number. "012" (12 VDC) or "024" (24 VDC).
 Example: E210A-1C012



10 MM MINIATURE VALVES

In-Line Connector with LED

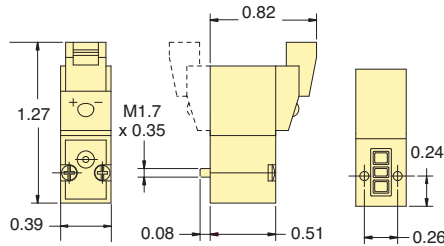

90° Connector with LED

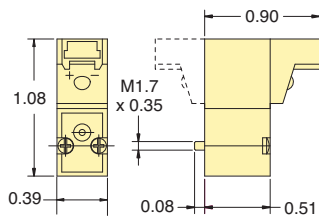

Wire Leads

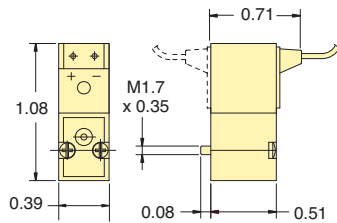

Typical Air Flow

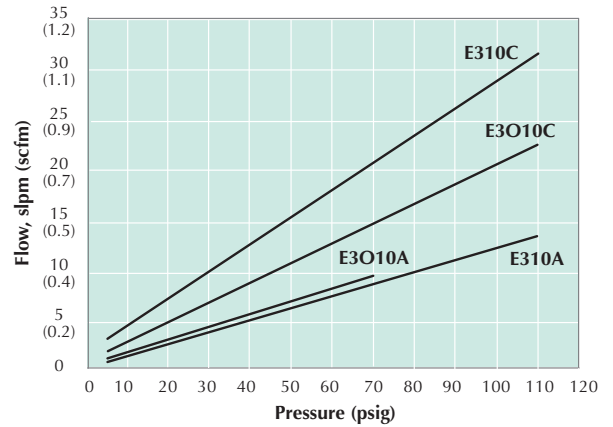

Mounting Interface

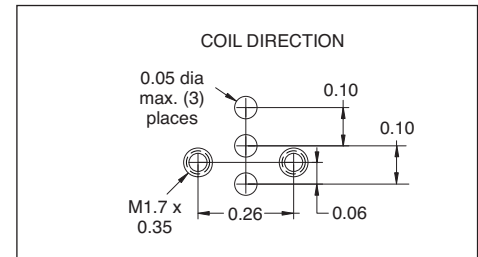

Connectors

Wire Connector must be ordered separately. 24 AWG. Stranding 7/32.

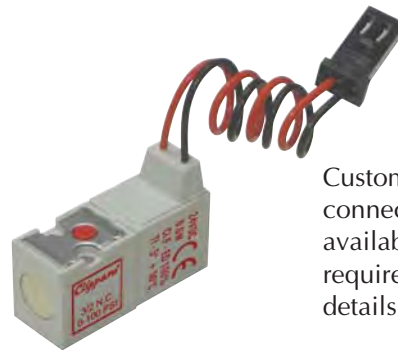

Custom plugs, wire lengths, connectors and flavors are available for your specific requirements. Call for details.

Part No.

- C2A-RB300 Connector with Cable, 11.8"
- C2A-RB500 Connector with Cable, 19.69"
- C2A-RB1000 Connector with Cable, 39.37"

Molex terminal insert #050013-8000, #28139 plug and 24 AWG wire.

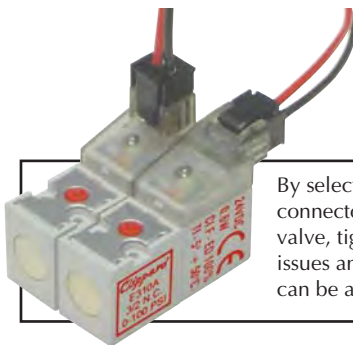

By selecting the appropriate connector type for your 10 mm valve, tight spaces, orientation issues and electrical requirements can be accommodated easily.

Another feature of the Clippard 10 mm valve is the ability to detach the coil and connector from the valve body. This can be useful for the purpose of orientating the coil by 180°, or exchanging connector types or voltages.



LATCHING 10 MM MINIATURE VALVES



- 2-Way & 3-Way Normally-Closed configurations
- Pulse-actuated (on or off)
- Polarity reverse required
- Stable latch

Clippard's 10 mm Latching Valves have many of the same features as the popular 10 mm valve line including small, compact design, exceptional life and reliability, light-weight design and more. A careful balance of forces—through the precise placement of a permanent magnet in the valve core—produces a bi-stable valve. A short pulse of current opens the valve, which “latches” open indefinitely after the current stops. A subsequent pulse of current in the opposite direction closes the valve. The valve consumes less energy and produces less heat than a standard solenoid valve when used in extended duty cycle applications, since the coil is energized for only a small fraction of the total duty cycle.

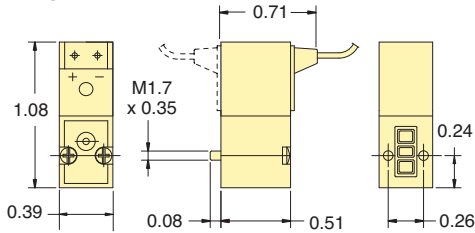

Max. Flow Rate: 31.2 l/min

Working Pressure: 0 to 110 psig

Orifice: 0.030"

Electrical Connection: 2-Wire Reverse Polarity, 300 mm, 24 AWG

Electrical: 12 VDC (“-012”) or 24 VDC (“-024”). 6 VDC also available. Call for further information.

Electrical Tolerance: -5 to +10%

Response Time: 8 ms when energized; 10 ms when de-energized

Connector: Wire Leads



Copper Wire Isolation Class: F 311°F

Material: Stainless steel core and springs, nylon body, FKM dynamic seals, and Nitrile gasket and static seals.

Temperature Range: 23 to 122°F. When below 32°F, must use clean, dry air

Medium: Air, Gas or other Compatible Fluids

Type	Part No.	Voltage	Wattage
2-Way	E2L10C-7W012	12 VDC	2.0
	E2L10C-7W024	24 VDC	
3-Way	E3L10C-7W012	12 VDC	2.0
	E3L10C-7W024	24 VDC	

Typical Air Flow

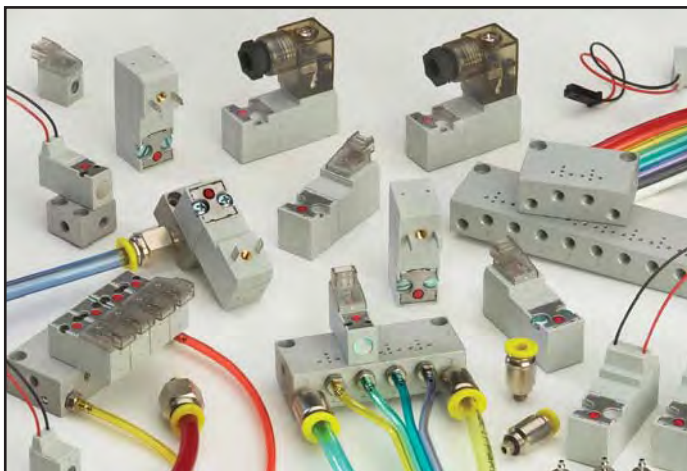
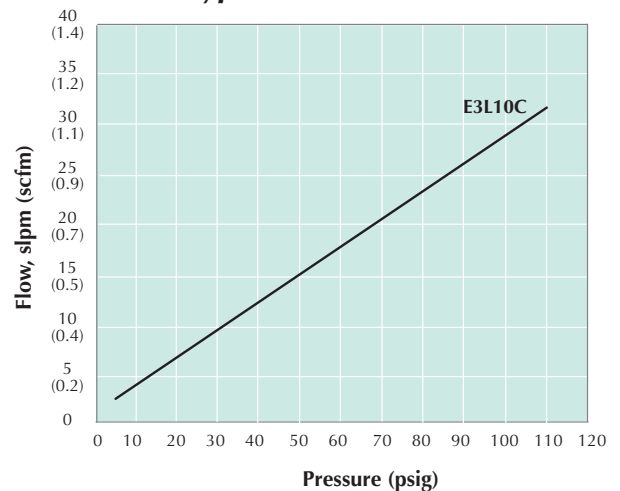

Mounting Interface

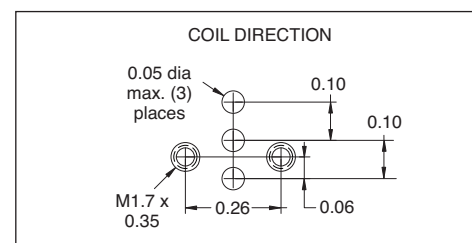

See [pages 224 & 227](#) for connectors and manifolds



HIGH FLOW 2-WAY 10 MM MINIATURE VALVES

Specifications

Medium: Air, Gas or other Compatible Fluids

Working Pressure: 0 to 30 psig

Max. Flow Rate: 28 lpm

Orifice: 0.055"

Response Time: 8 ms when energized; 10 ms when de-energized

Electrical: 12 VDC or 24 VDC

Power Consumption: 3.5 watts in rush phase; 15 ms/0.35 watts in maintenance phase

Voltage Tolerance: -5% to +10%

Material: Stainless steel core and springs, nylon body, FKM dynamic seals, and Nitrile gasket and static seals.

Temperature Range: 23 to 122°F. When below 32°F, must use clean, dry air



90° Connector with LED

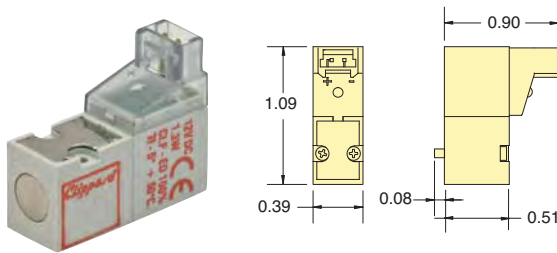

In-Line Connector with LED

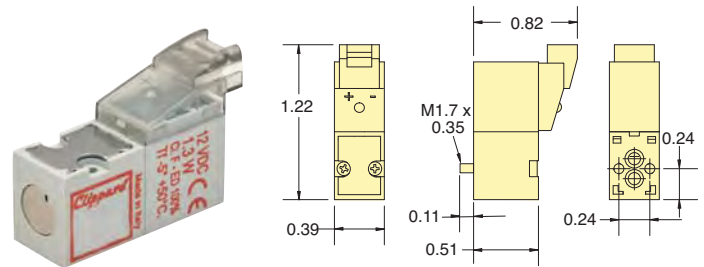

Part No.	Connector	Voltage
E210H-3L012	90° Connector	12 VDC
E210H-3L024	with LED	24 VDC
E210H-3C012	In-Line Connector	12 VDC
E210H-3C024	with LED	24 VDC

Typical Air Flow

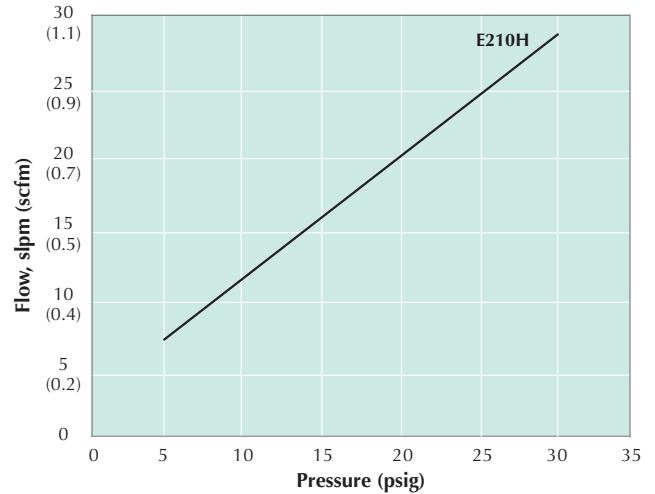

Mounting Interface

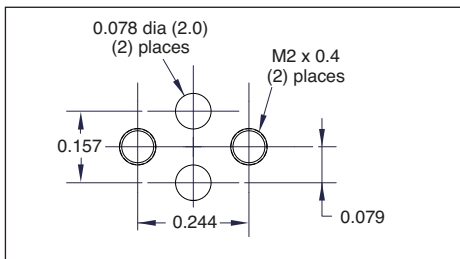

10 mm High Flow Single-Station Manifold

Spare hardware and closing plates available.

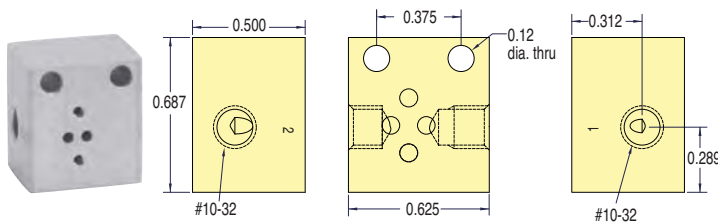

Part No.	Description
E10HM-01	10 mm Single-Station Manifold

Functional Schematics

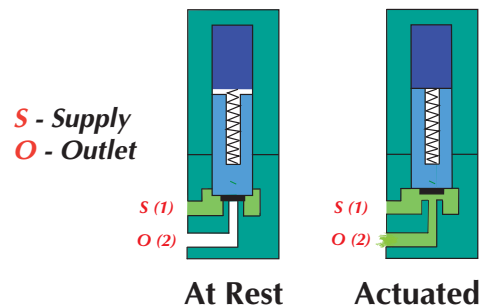

Specifications

Medium: Air, Gas, or other Compatible Fluids

Working Pressure: 0 to 102 psig

Maximum Flow Rate: 42 l/min

Exhaust Flow: 49 l/min

Orifice: 0.043"

Response Time: 8 ms when energized; 10 ms when de-energized

Material: Stainless steel core and springs, nylon body, FKM seals, and Nitrile gasket.

Voltage: 12-volt DC or 24-volt DC

Voltage Tolerance: -5% to +10%

Power Consumption: 3.5 watts in rush phase; 15 ms/0.35 watts in maintenance phase

Coil Insulation Class: F 311°F

Temperature Range: 23 to 122°F



90° Connector with LED

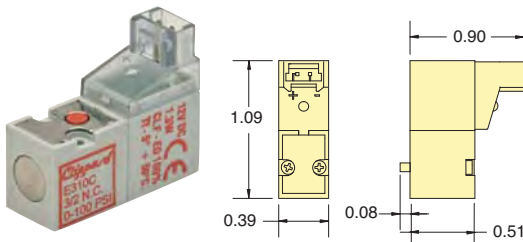

In-Line Connector with LED

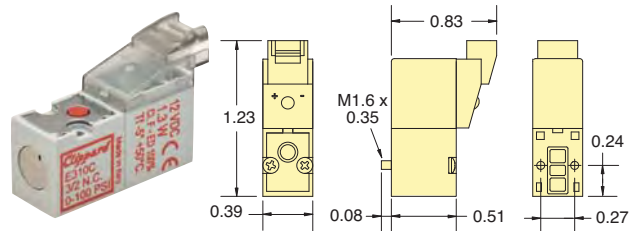

Part No.	Connector	Voltage
E311E-3L012	90° Connector	12 VDC
E311E-3L024	with LED	24 VDC
E311E-3C012	In-Line Connector	12 VDC
E311E-3C024	with LED	24 VDC

Mounting Interface

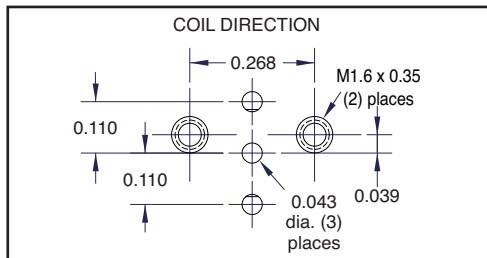

Typical Air Flow

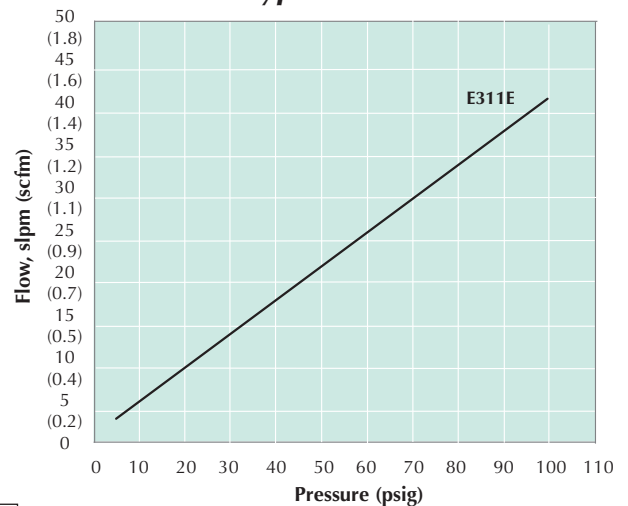

ISO 15218 10 mm High Flow Single-Station Manifold

Spare hardware and closing plates available.

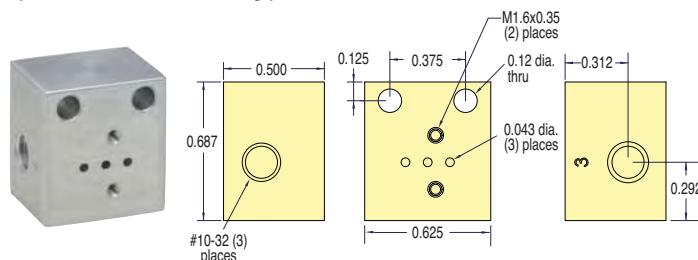

Part No.	Description
E10LM-01	ISO 10 mm Single-Station Manifold

Functional Schematics

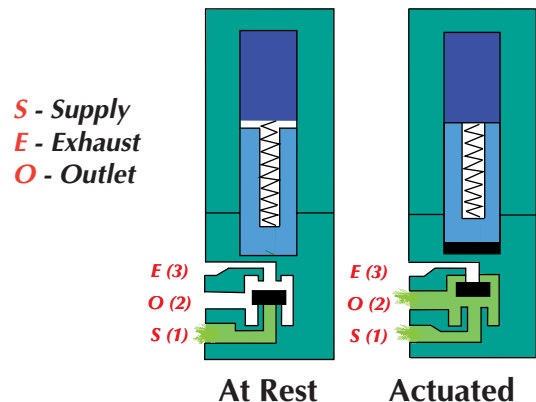



10 MM MINIATURE VALVE ACCESSORIES

Sub-Miniature Manifolds

Small, compact manifolds offer the efficient grouping of 10 mm valves along with fast installation. Easy manifold features a common inlet, individually-ported outlets, and exhaust to atmosphere.

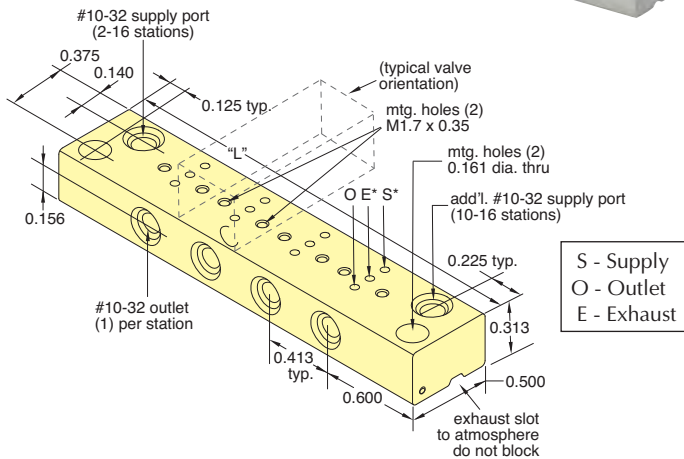

* For Normally-Open valves, supply to "E" and "S" becomes exhaust.

Stations	Supply Ports	Part No.	Length "L"
2	1	E10SM-02	1.61
4	1	E10SM-04	2.44
6	1	E10SM-06	3.27
8	1	E10SM-08	4.09
10	2	E10SM-10	4.92
12	2	E10SM-12	5.74
14	2	E10SM-14	6.57
16	2	E10SM-16	7.40

Cover Plate

Manifold Cover Plate includes plate, gasket and two screws.

Part No.
[E10M-CP](#) 10 mm Cover Plate

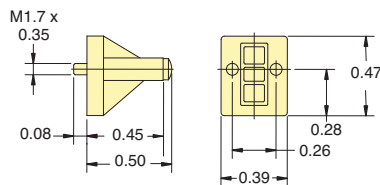

Standard Manifolds

Standard manifolds are available for one to 12 valves with ported exhaust. Spare hardware and closing plates available.

Part No.
[E10M-01](#) Single-Station Manifold

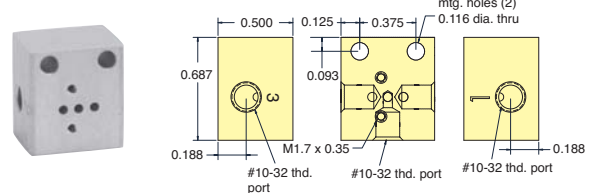

Multi-Station Manifolds

When using these manifolds with Normally-Closed valve configurations:

1. They cannot be used with Normally-Closed valves on the same manifold.
2. "E" becomes Supply, and "S" becomes Exhaust.

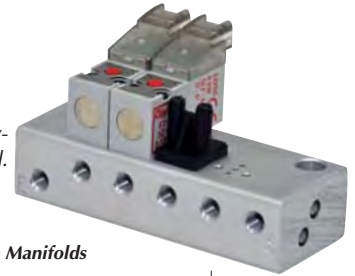

10- to 16-Station Manifolds

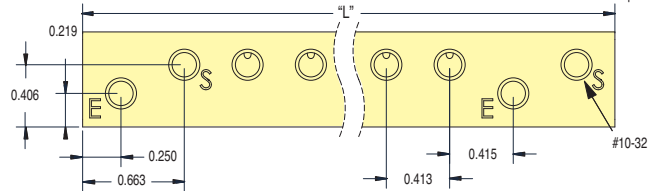
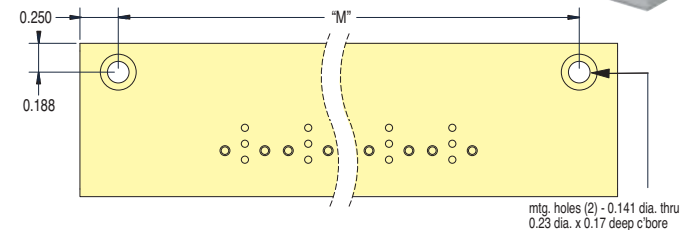

2- to 8-Station Manifolds

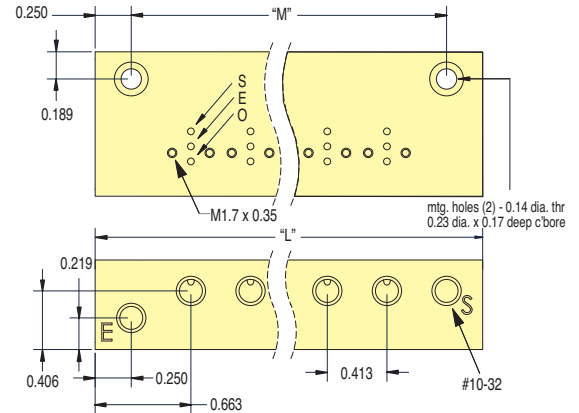

Part No.	Stations	Length "L"	Length "M"
E10M-02	2	1.74	1.24
E10M-04	4	2.57	2.07
E10M-06	6	3.39	2.89
E10M-08	8	4.22	3.72
E10M-10	10	5.87	5.37
E10M-12	12	6.70	6.20
E10M-14	14	7.52	7.02
E10M-16	16	8.35	7.85

15 MM MINIATURE VALVES



- Multiple Connectors
- Snap-in Plugs
 - Wire Leads
 - DIN Connector
 - Spade Terminals
 - Custom Plugs

LED for confirmation of operation available

Internal diodes for current spike suppression and a power saving circuit is available



Mounting Screws

HIGHLY VISIBLE manual override provides valve actuation without power

High durability and corrosion-resistant glass filled nylon housing

FKM seals and Nitrile gasket

2- or 3-ported valves in Normally-Closed and Normally-Open

One-piece gasket for manifold mount and supply/exhaust port reversed for same manifold mounting of N.O. or N.C. valve



Encapsulated low wattage coils. Available in: 12 VDC, 24 VDC, 24 VAC, 110 VAC or 220 VAC. Special voltages available for OEMs.

Configuration	1	2	3
N.C. & N.O.	exhaust	outlet	supply

Functional Schematics

Normally-Closed 3-Way Valve

S - Supply
E - Exhaust
O - Outlet

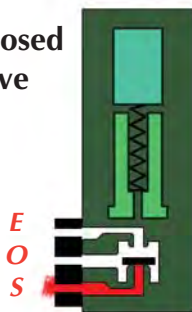

At Rest

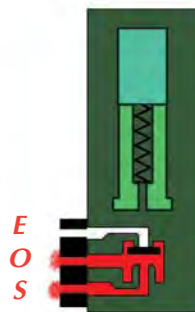

Actuated

Normally-Open 3-Way Valve

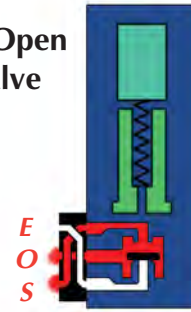

At Rest

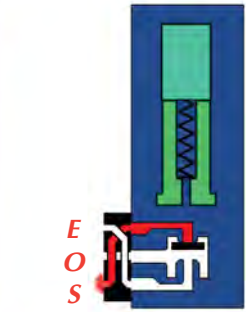

Actuated



Porting Gasket

The Normally-Open and Normally-Closed configurations allow both models to be mounted on the same manifold.

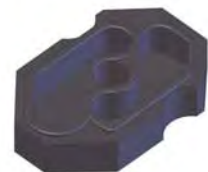



15 MM MINIATURE VALVES

Specifications

Medium: Air, Gas, or other Compatible Fluids

Working Pressure: See Chart below.

Maximum Flow Rate:
 0.032" Orifice: 45 l/min
 0.043" Orifice: 70 l/min
 0.063" Orifice: 91 l/min

Response Time: 10 ms when energized; 12 ms when de-energized



Material: Stainless steel core and springs, springs, nylon body, FKM seals, and Nitrile gasket.

Voltage: 12-volt DC, 24-volt DC or 24-volt AC. 110-volt AC and 220-volt AC only available with DIN Connectors.

Voltage Tolerance: -5% to +10%

Power Consumption: 1.0 or 2.5 watts dependent on orifice size and pressure

Coil Insulation Class: F 311°F

Temperature Range: 23 to 122°F



Order Information

Type	Base No.	Connector	12	24	24	110	220	Orifice	Wattage	Working Pressure
			VDC	VDC	VAC	VAC	VAC			
2/2 Normally-Closed 	E215D-1T*	Terminal	•	•				0.032"	1.0	0 to 150 psig
	E215E-2T*		•	•	•			0.043"	2.5	0 to 150 psig
	E215F-2T*		•	•	•			0.063"	2.5	0 to 110 psig
	E215D-1D*	DIN Connector	•	•				0.032"	1.0	0 to 150 psig
	E215E-2D*		•	•	•	•	•	0.043"	2.5	0 to 150 psig
	E215F-2D*		•	•	•	•	•	0.063"	2.5	0 to 110 psig
	E215D-1W*	Wire Leads, 11.8"	•	•				0.032"	1.0	0 to 150 psig
	E215E-2W*		•	•	•			0.043"	2.5	0 to 150 psig
	E215F-2W*		•	•	•			0.063"	2.5	0 to 110 psig
	E215D-1L*	90° Connector with LED	•	•				0.032"	1.0	0 to 150 psig
	E215E-2L*		•	•				0.043"	2.5	0 to 150 psig
	E215F-2L*		•	•				0.063"	2.5	0 to 110 psig
E215D-1C*	In-Line Connector with LED	•	•				0.032"	1.0	0 to 150 psig	
E215E-2C*		•	•				0.043"	2.5	0 to 150 psig	
E215F-2C*		•	•				0.063"	2.5	0 to 110 psig	
3/2 Normally-Closed 	E315D-1T*	Terminal	•	•				0.032"	1.0	0 to 150 psig
	E315E-2T*		•	•	•			0.043"	2.5	0 to 150 psig
	E315F-2T*		•	•	•			0.063"	2.5	0 to 110 psig
	E315D-1D*	DIN Connector	•	•				0.032"	1.0	0 to 150 psig
	E315E-2D*		•	•	•	•	•	0.043"	2.5	0 to 150 psig
	E315F-2D*		•	•	•	•	•	0.063"	2.5	0 to 110 psig
	E315D-1W*	Wire Leads, 11.8"	•	•				0.032"	1.0	0 to 150 psig
	E315E-2W*		•	•	•			0.043"	2.5	0 to 150 psig
	E315F-2W*		•	•	•			0.063"	2.5	0 to 110 psig
	E315D-1L*	90° Connector with LED	•	•				0.032"	1.0	0 to 150 psig
	E315E-2L*		•	•				0.043"	2.5	0 to 150 psig
	E315F-2L*		•	•				0.063"	2.5	0 to 110 psig
E315D-1C*	In-Line Connector with LED	•	•				0.032"	1.0	0 to 150 psig	
E315E-2C*		•	•				0.063"	2.5	0 to 150 psig	
E315F-2C*		•	•				0.063"	2.5	0 to 110 psig	
3/2 Normally-Open (110 psig max.) 	E3O15E-2T*	Terminal	•	•	•			0.043"	2.5	0 to 110 psig
	E3O15F-2T*		•	•	•			0.063"	2.5	0 to 75 psig
	E3O15E-2D*	DIN Connector	•	•	•	•	•	0.043"	2.5	0 to 110 psig
	E3O15F-2D*		•	•	•	•	•	0.063"	2.5	0 to 75 psig
	E3O15E-2W*	Wire Leads, 11.8"	•	•	•			0.043"	2.5	0 to 110 psig
	E3O15F-2W*		•	•	•			0.063"	2.5	0 to 75 psig
	E3O15E-2L*	90° Connector with LED	•	•				0.043"	2.5	0 to 110 psig
	E3O15F-2L*		•	•				0.063"	2.5	0 to 75 psig
E3O15E-2C*	In-Line Connector with LED	•	•				0.063"	2.5	0 to 110 psig	
E3O15F-2C*		•	•				0.063"	2.5	0 to 75 psig	

• Indicates standard items

* Add Voltage Choice to the end of each Base Part Number. "012" (12 VDC), "024" (24 VDC) "24A" (24 VAC), "110" (110 VAC) or "220" (220 VAC). Example: **E315D-1C012**

15 MM MINIATURE VALVES



Terminal Connector



Industrial Form C Connector ordered separately below.

DIN Connector



DIN Connector ordered separately below.

In-Line Connector with LED



Wire Leads

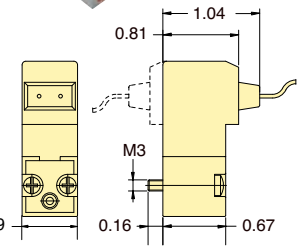
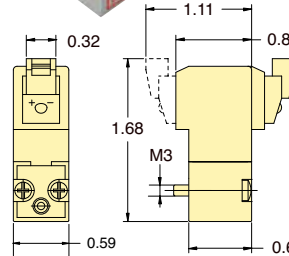
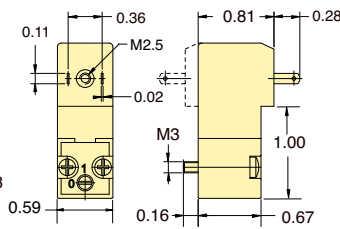
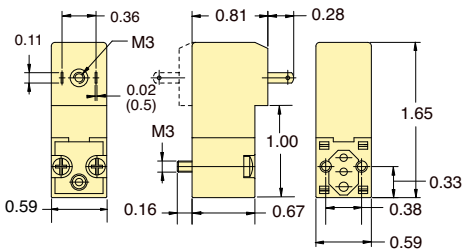

90° Connector with LED

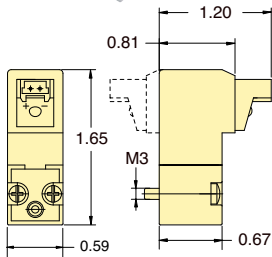

Typical Air Flow

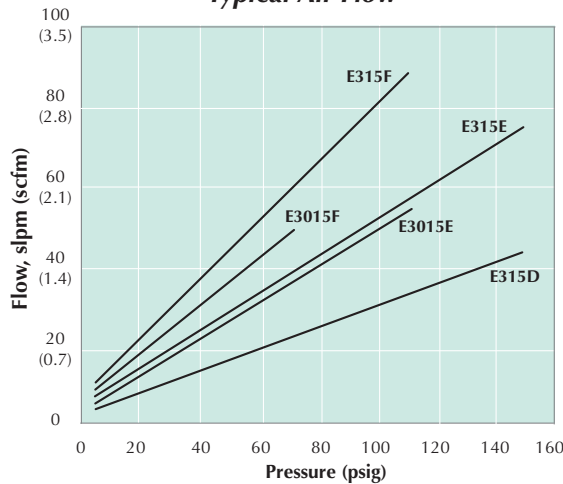

Mounting Interface

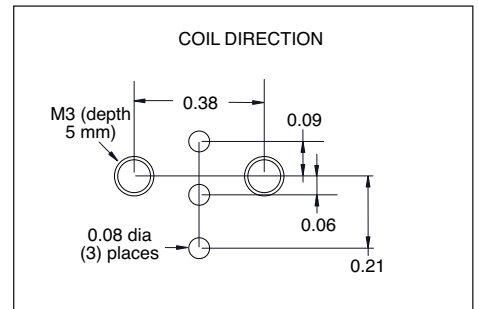

DIN Connectors

For Use with 15 mm Valves Only

DIN 43650 Form C Connectors with 8 mm spade center spacing mate with the 15 mm DIN connector coil. Industrial Form Connectors with 9.4 mm spade center spacing are designed to connect to 15 mm terminal coils. Both are available with or without surge suppression, and 152 or 381 mm PVC molded three-wire cord set.

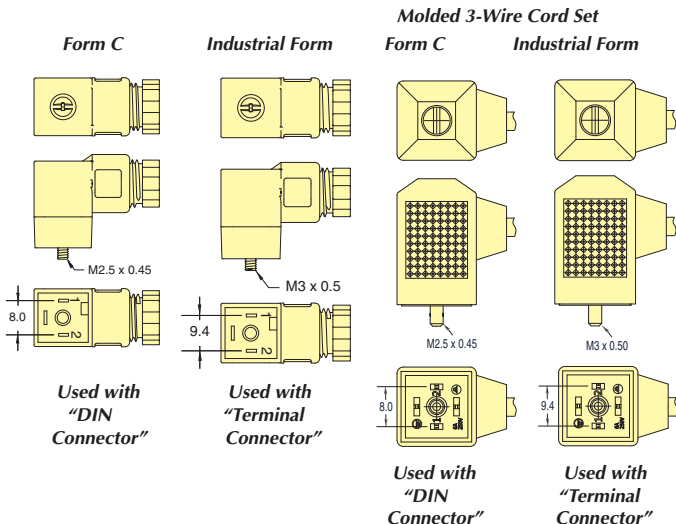

Form C Part No.	Industrial Form Part No.	Volts	LED	Cord
CC-C	CC-I	6-240	no	-
CC-C-P6	CC-I-P6	6-240	no	6'
CC-C-P15	CC-I-P15	6-240	no	15'
CC-CLL	CC-ILL	6-24	yes	-
CC-CLL-P6	CC-ILL-P6	6-24	yes	6'
CC-CLL-P15	CC-ILL-P15	6-24	yes	15'
CC-CLM	CC-ILM	48-110	yes	-
CC-CLM-P6	CC-ILM-P6	48-110	yes	6'
CC-CLM-P15	CC-ILM-P15	48-110	yes	15'



LATCHING 15 MM MINIATURE VALVES



- 2-Way & 3-Way Normally-Closed configurations
- Pulse-actuated (on or off)
- 3-wire coil. No polarity reverse required
- Stable latch

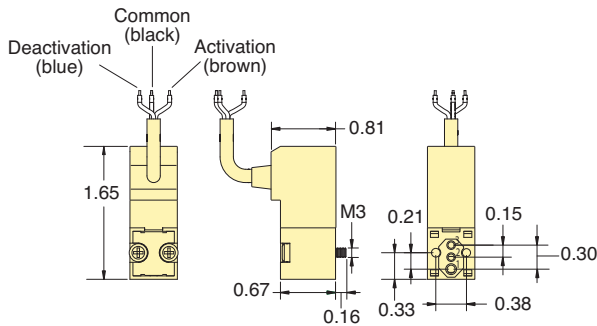

Clippard's 15 mm Latching Valves have many of the same features as the popular 15 mm standard valve line including small, compact design, exceptional life and reliability, light-weight design and more. A careful balance of forces—through the precise placement of a permanent magnet in the valve core—produces a bi-stable valve. A short pulse of current opens the valve, which “latches” open indefinitely after the current stops. A subsequent pulse of current in the opposite direction closes the valve. The valve consumes less energy and produces less heat than a standard solenoid valve when used in extended duty cycle applications, since the coil is energized for only a small fraction of the total duty cycle.

Medium: Air, Gas or other Compatible Fluids

Max. Flow Rate: 0.043" Orifice: 59 l/min
0.063" Orifice: 84 l/min

Electrical Connection: 3-Wire Molded Cord, 300 mm, 24 AWG 4.5 mm external jacket; tinned copper wires; silicone jacket and conductor insulation)

Electrical: 12 VDC (“-012”) or 24 VDC (“-024”). 6 VDC also available. Call for further information.

Electrical Tolerance: -5 to +10%



Response Time: 10 ms when energized; 12 ms when de-energized

Copper Wire Isolation Class: F 311°F

Material: Stainless steel core and springs, nylon body, FKM dynamic seals, and Nitrile gasket and static seals.

Temperature Range: 23 to 122°F. When below 32°F, must use clean, dry air

Mounting Interface

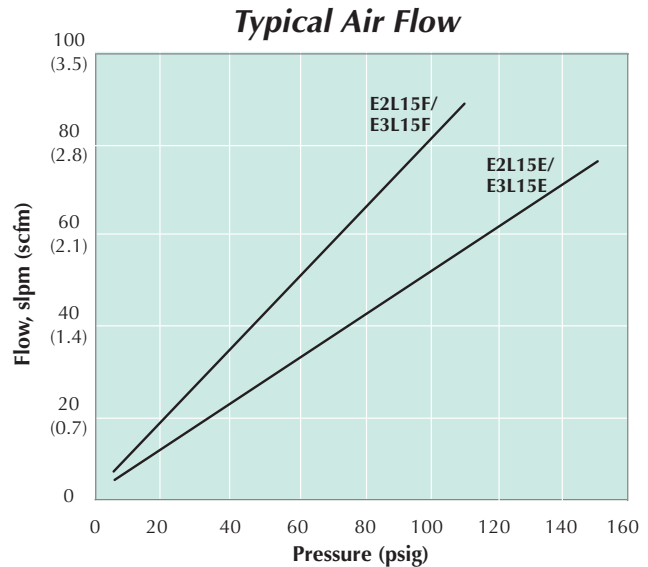
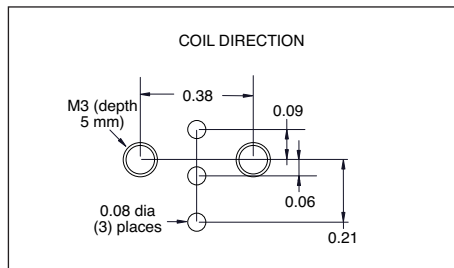

Type	Part No.	Connector	Orifice	Voltage	Wattage	Pressure Range
2-Way	E2L15E-4W012	3-Wire Molded Cord, 300 mm	0.043"	12 VDC	4.0	0 to 150 psig
	E2L15E-4W024		0.043"	24 VDC		0 to 150 psig
	E2L15F-4W012		0.063"	12 VDC		0 to 110 psig
	E2L15F-4W024		0.063"	24 VDC		0 to 110 psig
3-Way	E3L15E-4W012	3-Wire Molded Cord, 300 mm	0.043"	12 VDC	4.0	0 to 150 psig
	E3L15E-4W024		0.043"	24 VDC		0 to 150 psig
	E3L15F-4W012		0.063"	12 VDC		0 to 110 psig
	E3L15F-4W024		0.063"	24 VDC		0 to 110 psig

See [page 214](#) for connectors and manifolds

HIGH FLOW 2-WAY N.C. 15 MM VALVES



Specifications

Medium: Air, Gas, or other Compatible Fluids

Working Pressure: 0 to 43 psig

Maximum Flow Rate: 120 l/min

Orifice: 0.118"

Material: Stainless steel core and springs, nylon body, FKM seals, and Nitrile gasket.

Response Time: 10 ms when energized; 12 ms when de-energized

Voltage: 12-volt DC or 24-volt DC

Voltage Tolerance: -5% to +10%

Power Consumption: 4.0 watts

Coil Insulation Class: F 311°F

Temperature Range: 23 to 122°F



90° Connector with LED

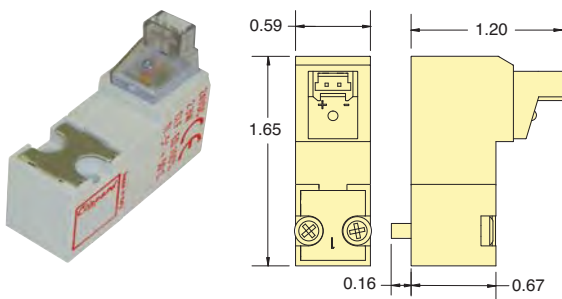

In-Line Connector with LED

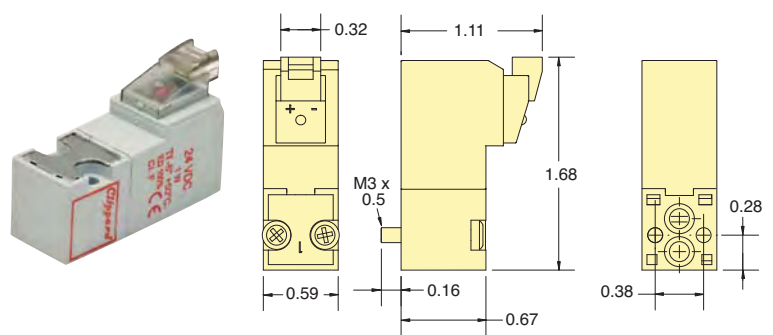

Part No.	Connector	Voltage
E215H-3L012	90° Connector	12 VDC
E215H-3L024	90° Connector with LED	24 VDC
E215H-3C012	In-Line Connector	12 VDC
E215H-3C024	In-Line Connector with LED	24 VDC

Mounting Interface

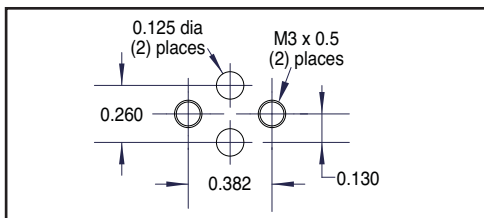

Typical Air Flow

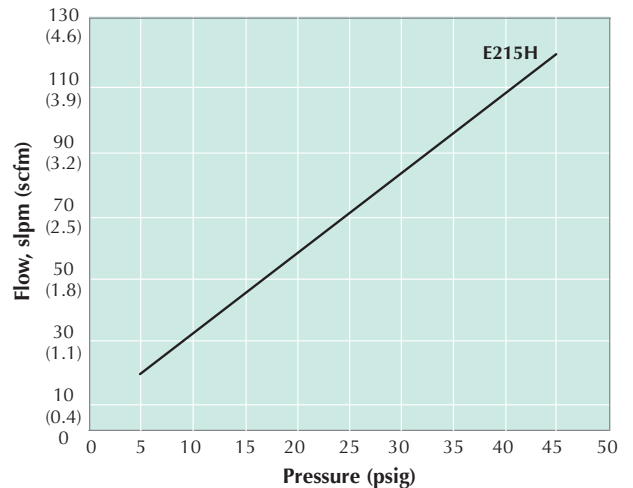

15 mm High Flow Single-Station Manifold

Spare hardware and closing plates available.

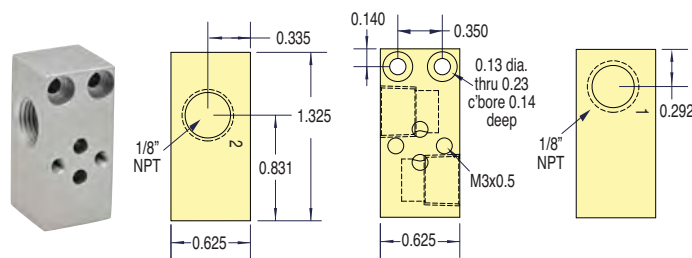

Part No.
[E15HM-01](#) 15 mm Single-Station Manifold

Metric line available. Visit www.clippard.com

Functional Schematics

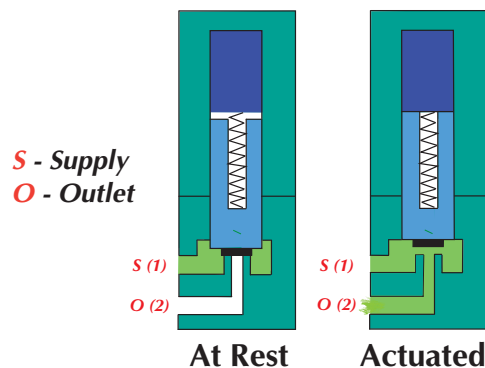



15 MM VALVE ACCESSORIES

Sub-Miniature Manifolds

Small, compact manifolds offer the efficient grouping of 15 mm valves along with fast installation. Each manifold features a common inlet, individually-ported outlets, and exhaust to atmosphere.

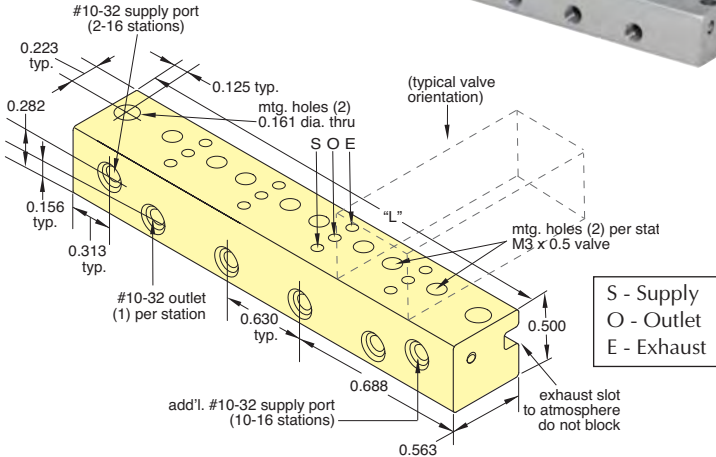
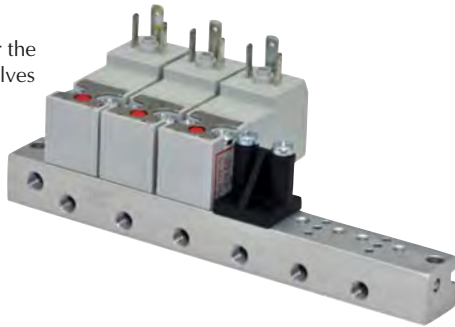

Stations	Supply Ports	Part No.	Length "L"
2	1	E15SM-2	2.01
4	1	E15SM-4	3.27
6	1	E15SM-6	4.53
8	1	E15SM-8	5.79
10	2	E15SM-10	7.05
12	2	E15SM-12	8.31
14	2	E15SM-14	9.57
16	2	E15SM-16	10.82



Connectors

Wire Connector must be ordered separately. 24 AWG. Stranding 7/32.

Part No.

- [C2A-RB300](#) Connector with Cable, 11.8"
- [C2A-RB500](#) Connector with Cable, 19.69"
- [C2A-RB1000](#) Connector with Cable, 39.37"

Molex terminal insert #050013-8000, #28139 plug and 24 AWG wire.

Cover Plate

Manifold Cover Plate includes plate, gasket and two screws.

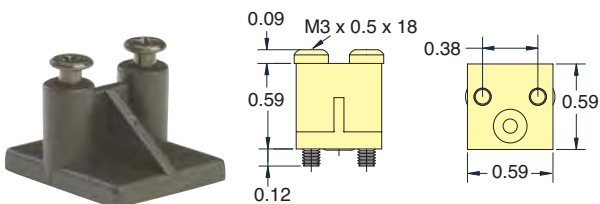

Part No.

[E15M-CP](#) 15 mm Cover Plate

Standard Manifolds

Standard manifolds are available for one to 16 valves with ported exhaust. Spare hardware and closing plates also available.

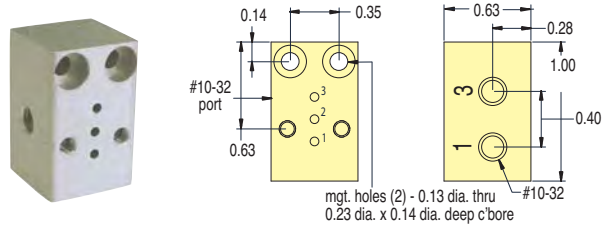

Part No.

[E15M-01](#) Single-Station Manifold

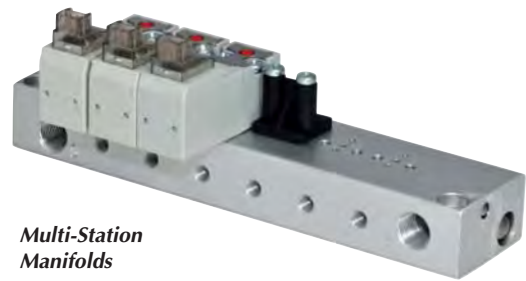

Multi-Station Manifolds

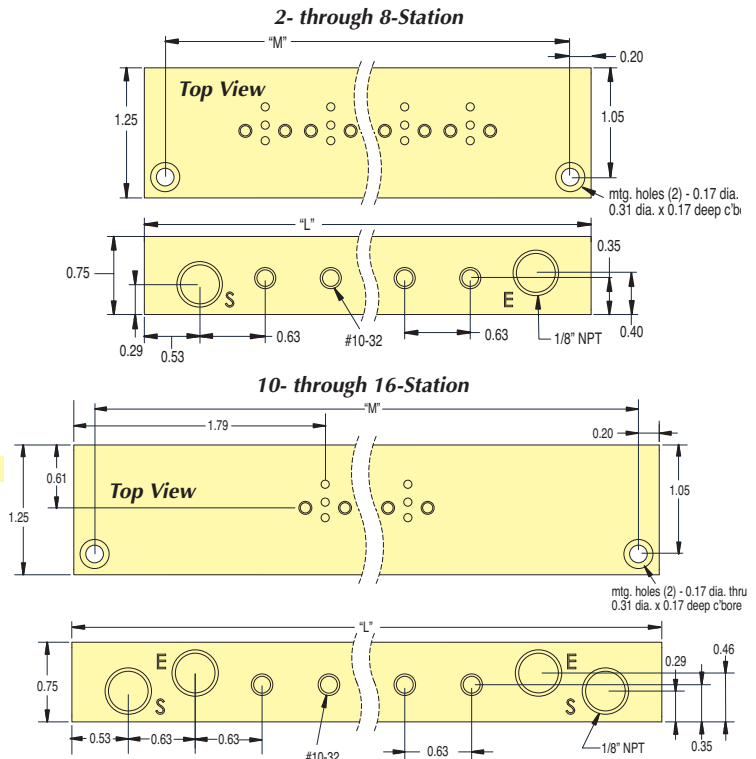

Stations	Part No.	Length "L"	Length "M"
2	E15M-02	2.95	2.55
4	E15M-04	4.21	3.81
6	E15M-06	5.47	5.07
8	E15M-08	6.73	6.33
10	E15M-10	9.25	8.85
12	E15M-12	10.51	10.1
14	E15M-14	11.77	11.4
16	E15M-16	13.03	12.6



Maximatic®



Maximatic Solenoid Valves

Clippard's Maximatic Solenoid valves are available in 2-way, 3-way and 4-way configurations in port sizes from #10-32 to 1/2" NPT. Select either a direct-acting poppet or solenoid-controlled pilot operated balanced spool design. Spool valves are body ported but can be bolted to a parallel circuit manifold.

These electronic valves offer high flow in a small package, and are constructed of aluminum, stainless steel and thermoplastic materials. The 4-way valves are also available in 3 position versions with either pressure center, closed center or exhaust center spool options.

Materials: Aluminum, Stainless Steel, Thermoplastic

Maximum Pressure: 0 to 115 psig (direct-acting only); 30 to 125 on MME-41 Series, 20 to 125 psig on all others (spool valves)

Response Time: Less than 20 milliseconds

Mounting: Manifold standard. Actuator (1/4" only) or NAMUR (3/8" NPT only) available.

Manual Override: Locking or non-locking

Electrical Connection: DIN terminal with LED indicator, or 18" Wire Leads

DIN Connector: Plug-in electrical connector with LED. MME-31/41 models are DIN Industrial Form "C" (9.4 mm centers) 3 mm screw. All others are DIN 43650 Form "B" 3 mm screw. LED will not "light" if polarity is reversed.

Wire Leads: Not polarity sensitive

Temperature Range: 32 to 150°F

Seals: Nitrile

Conforms to ISO 19973-2 test standards.

3- & 4-Way Valves

Port	Cv	Flow Rate	
		@ 50 psig	@ 100 psig
#10-32	0.58	16 scfm	27 scfm
1/8" NPT	0.67	18 scfm	31 scfm
1/4" NPT	0.89	26 scfm	49 scfm
3/8" NPT	1.68	51 scfm	93 scfm
1/2" NPT	2.79	91 scfm	171 scfm

Metric line available. Visit www.clippard.com



Maximum Value. Maximum Performance.

For side ported manifold mount, the Maximatic line of valves offers both 1/4" actuator mount and 3/8" NAMUR mount

2-Way, 3-Way & 4-Way Designs

Choose either DIN connector with LED indicator or 18" Wire Lead connection. Both are rotatable and interchangeable.

Easily accessible locking or non-locking manual override switch

Port sizes from #10-32 to 1/2" NPT

Small size makes valves ideal for use in compact applications

Nitrile Seals

Sturdy aluminum body withstands rough environments

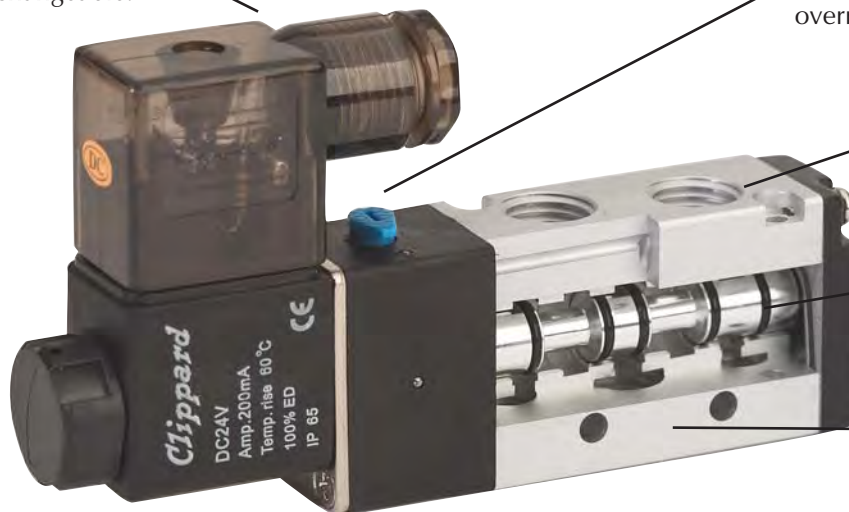

Operating ranges to 125 psig

Closed Center, Pressure Center and Exhaust Center Models Available

Maximatic® Valves are available as body ported, manifold mount, NAMUR (3/8" NPT only), and Actuator (1/4" NPT only) mounting. Standard models include a base that permits fast, secure mounting of electronic valves to a manifold for grouping in compact assemblies.

A wide variety of voltage options are available including 12 VDC, 24 VDC, 24 VAC, 110 VAC and 220 VAC. Consult factory for other voltages.

All Maximatic® Solenoid Valves are IP 65 CE Rating

MAXIMATIC® SOLENOID VALVES

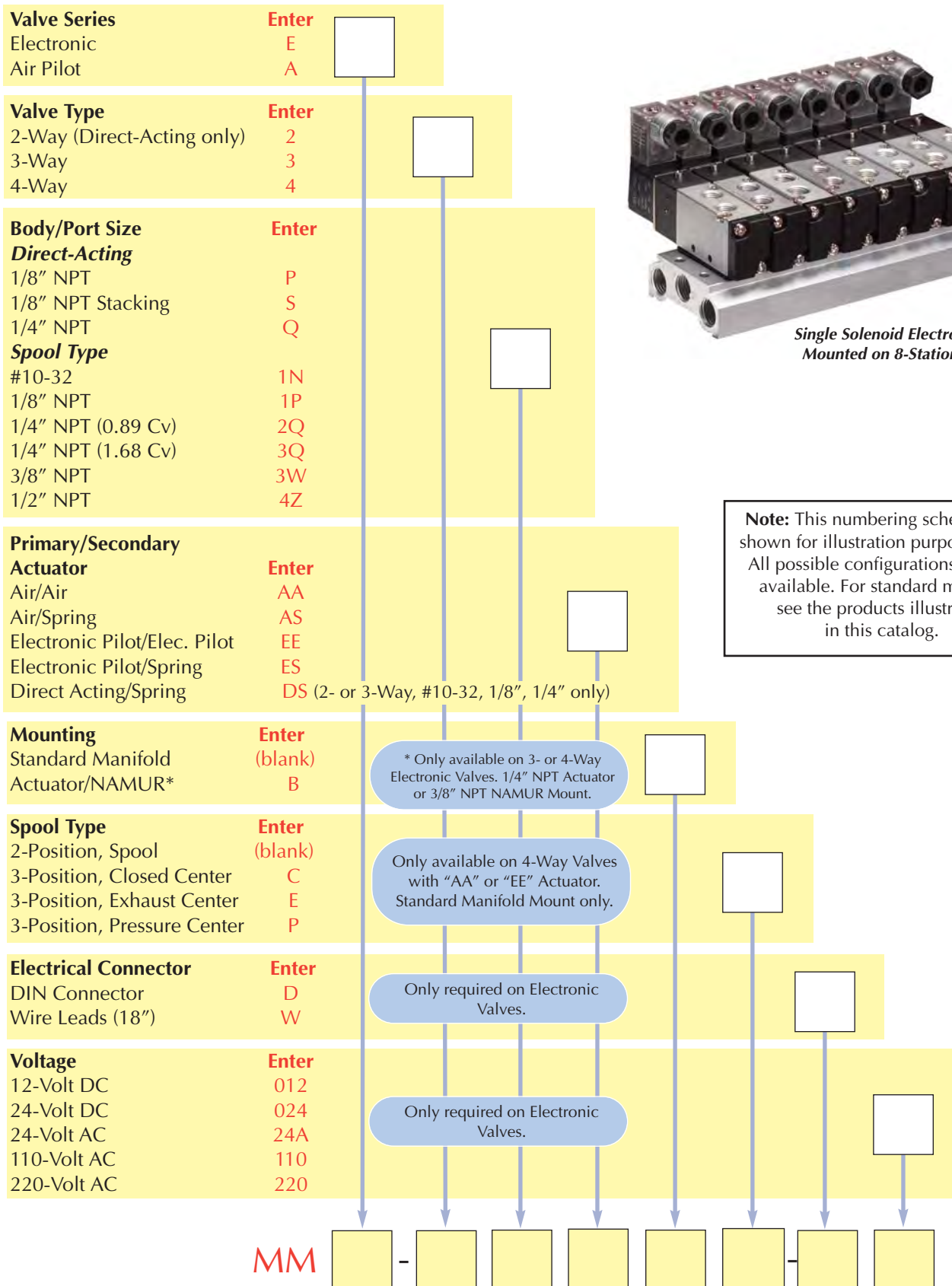

Single Solenoid Electronic Valves Mounted on 8-Station Manifold

Note: This numbering schematic is shown for illustration purposes only. All possible configurations are not available. For standard models, see the products illustrated in this catalog.

Metric line available. Visit www.clippard.com

Example: MM E - 4 2Q ES - D 110



MAXIMATIC® SOLENOID VALVES

2-Way Valves										
Series No.	Style	Inlet	Ports Outlet	Exhaust	Function	Cv	Flow @ 100 psig			
MME-2PDS	Poppet	1/8" NPT	1/8" NPT	1/8" NPT	2/2	0.12	6.7 scfm			
MME-2QDS	Poppet	1/4" NPT	1/4" NPT	1/4" NPT	2/2	0.12	6.7 scfm			
MME-2SDS	Poppet	1/8" NPT	1/8" NPT	1/8" NPT	2/2	0.05	2.3 scfm			
3-Way Valves										
MME-3PDS	Poppet	1/8" NPT	1/8" NPT	1/8" NPT	3/2	0.12	6.7 scfm			
MME-3QDS	Poppet	1/4" NPT	1/4" NPT	1/4" NPT	3/2	0.12	6.7 scfm			
MME-3SDS	Poppet	1/8" NPT	1/8" NPT	1/8" NPT	3/2	0.05	2.3 scfm			
MME-31NES	Spool	#10-32	#10-32	#10-32	3/2 NC	0.58	27 scfm			
MME-31PES	Spool	1/8" NPT	1/8" NPT	1/8" NPT	3/2 NC	0.67	31 scfm			
MME-32QES	Spool	1/4" NPT	1/4" NPT	1/8" NPT	3/2 NC	0.89	49 scfm			
MME-33WES	Spool	3/8" NPT	3/8" NPT	1/4" NPT	3/2 NC	1.68	93 scfm			
MME-34ZES	Spool	1/2" NPT	1/2" NPT	1/2" NPT	3/2 NC	2.79	171 scfm			
MME-31NEE	Spool	#10-32	#10-32	#10-32	3/2	0.58	27 scfm			
MME-31PEE	Spool	1/8" NPT	1/8" NPT	1/8" NPT	3/2	0.67	31 scfm			
MME-32QEE	Spool	1/4" NPT	1/4" NPT	1/8" NPT	3/2	0.89	49 scfm			
MME-33WEE	Spool	3/8" NPT	3/8" NPT	1/4" NPT	3/2	1.68	93 scfm			
MME-34ZEE	Spool	1/2" NPT	1/2" NPT	1/2" NPT	3/2	2.79	171 scfm			
4-Way Valves										
Series No.	Style	Inlet	Ports Outlet	Exhaust	Function	Cv	Flow @ 100 psig	Spool Configuration		
								Flow @ 100 psig	Center	Exhaust Center
MME-41NES	Spool	#10-32	#10-32	#10-32	5/2	0.58	27 scfm			
MME-41PES	Spool	1/8" NPT	1/8" NPT	1/8" NPT	5/2	0.67	31 scfm			
MME-42QES	Spool	1/4" NPT	1/4" NPT	1/8" NPT	5/2	0.89	49 scfm			
MME-43WES	Spool	3/8" NPT	3/8" NPT	1/4" NPT	5/2	1.68	93 scfm			
MME-44ZES	Spool	1/2" NPT	1/2" NPT	1/2" NPT	5/2	2.79	171 scfm			
MME-41NEE	Spool	#10-32	#10-32	#10-32	5/2	0.58	27 scfm			
MME-41PEE	Spool	1/8" NPT	1/8" NPT	1/8" NPT	5/2	0.67	31 scfm			
MME-42QEE	Spool	1/4" NPT	1/4" NPT	1/8" NPT	5/2	0.89	49 scfm			
MME-43WEE	Spool	3/8" NPT	3/8" NPT	1/4" NPT	5/2	1.68	93 scfm			
MME-44ZEE	Spool	1/2" NPT	1/2" NPT	1/2" NPT	5/2	2.79	171 scfm			
MME-41NEEC	Spool	#10-32	#10-32	#10-32	5/3	0.50	23 scfm		•	
MME-41PEEC	Spool	1/8" NPT	1/8" NPT	1/8" NPT	5/3	0.50	23 scfm		•	
MME-42QEEC	Spool	1/4" NPT	1/4" NPT	1/8" NPT	5/3	0.67	49 scfm		•	
MME-43WEEC	Spool	3/8" NPT	3/8" NPT	1/4" NPT	5/3	1.00	72 scfm		•	
MME-44ZEEC	Spool	1/2" NPT	1/2" NPT	1/2" NPT	5/3	1.68	93 scfm		•	
MME-41NEEP	Spool	#10-32	#10-32	#10-32	5/3	0.50	23 scfm			•
MME-41PEEP	Spool	1/8" NPT	1/8" NPT	1/8" NPT	5/3	0.50	23 scfm			•
MME-42QEEP	Spool	1/4" NPT	1/4" NPT	1/8" NPT	5/3	0.89	49 scfm			•
MME-43WEEP	Spool	3/8" NPT	3/8" NPT	1/4" NPT	5/3	1.00	72 scfm			•
MME-44ZEEP	Spool	1/2" NPT	1/2" NPT	1/2" NPT	5/3	1.68	93 scfm			•
MME-41NEEE	Spool	#10-32	#10-32	#10-32	5/3	0.50	23 scfm		•	
MME-41PEEE	Spool	1/8" NPT	1/8" NPT	1/8" NPT	5/3	0.50	23 scfm		•	
MME-42QEEE	Spool	1/4" NPT	1/4" NPT	1/8" NPT	5/3	0.89	49 scfm		•	
MME-43WEEE	Spool	3/8" NPT	3/8" NPT	1/4" NPT	5/3	1.00	72 scfm		•	
MME-44ZEEE	Spool	1/2" NPT	1/2" NPT	1/2" NPT	5/3	1.68	93 scfm		•	



Direct-Acting 2-Position Solenoid Valves



Maximatic® Direct-Acting Valves are single solenoid spring return poppet type valves available as either 2-way or 3-way configurations in ports sizes 1/8" NPT and 1/4" NPT. Hardware to stack multiple valves included with each stacking valve (MME-3SDS and MME-2SDS).

Includes two long screws, two short screw, one gasket, and two nuts.

Medium: Air (40 micron filtration), Inert Gas or Liquid
Operating Range: 0 to 115 psig
Flow: 2.3 scfm @ 100 psig
Electrical Connection: DIN connector with LED indicator ("D"), or 18" Wire Lead ("-W")
Voltage: 12-volt DC ("-012"), 24-volt DC ("-024"), 24-volt AC ("-24A"), 110-volt AC ("-110"), or 220-volt AC ("-220")
Power Consumption: 6.5 Watt
Number of Ports: 2 or 3
Mounting: Body Ported or Stacking

Replacement Stacking Kit

Replacement Stacking Kits are available which include two long screws, two short screws, one gasket and two nuts.

Part No.	Description
<u>27048</u>	Replacement Stacking Kit

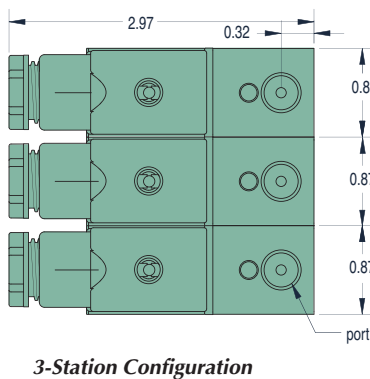

2-Way & 3-Way Valves (stacking) 2-Way & 3-Way Valves (non-stacking)

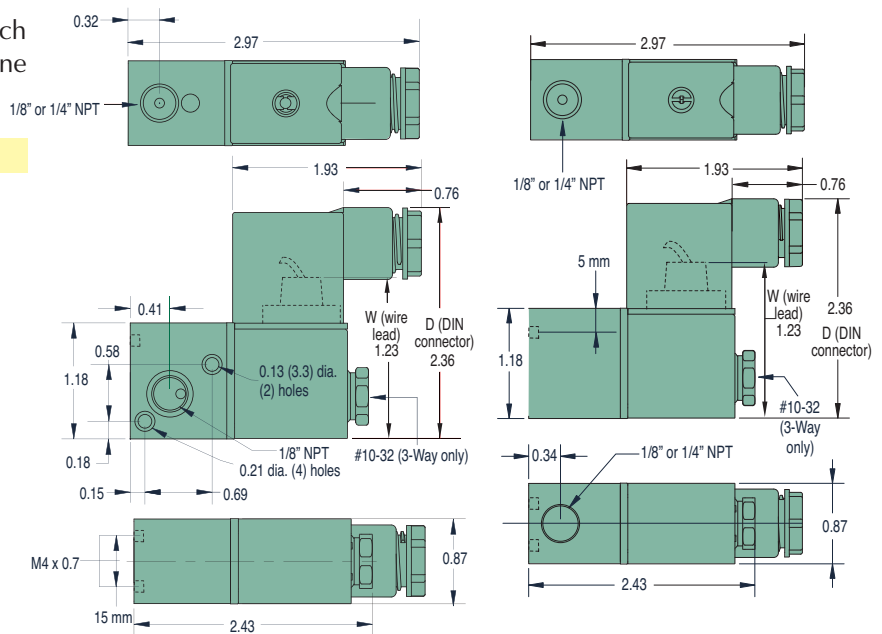

2-Way Valves	Cv/scfm*	3-Way Valves	Inlet	Outlet	Exhaust	Cv/scfm*
<u>MME-2PDS-</u> A	0.12/6.7	<u>MME-3PDS-</u> A	1/8" NPT	1/8" NPT	#10-32	0.10/2.3
<u>MME-2SDS-*</u> W	0.05/2.3	<u>MME-3SDS-*</u> W	1/8" NPT	1/8" NPT	#10-32	0.10/2.3
<u>MME-2QDS-</u> P	0.12/6.7	<u>MME-3QDS-</u> P E	1/4" NPT	1/4" NPT	#10-32	0.10/2.3

** Stacking Valve

* scfm based on flow @ 100 psig

Add Electrical Connection and Voltage Choices to the end of each Base Part Number - Example: MME-2QDS-W220



MAXIMATIC® 3-WAY VALVES

2-Position Single & Double Solenoid Valves



MME-33WES-D110



MME-32QEE-D110

Maximatic® 3-way electronic valves are either N.C. single solenoid spring return or double solenoid spool valves in #10-32 to 1/2" NPT port sizes.

Medium: Air (40 micron filtration) or Inert Gas

Operating Range: 20 to 125 psig

Electrical Connection: DIN connector with LED indicator ("-D"), or 18" Wire Lead ("-W")

Voltage: 12-volt DC ("-012"), 24-volt DC ("-024"), 24-volt AC ("-24A"), 110-volt AC ("-110"), or 220-volt AC ("-220")

Number of Ports: 3

Mounting: Body Ported, Manifold Mount, Actuator (1/4" NPT only) or NAMUR (3/8" NPT only) available. See [Page 234](#).

Manual Override: Non-locking on MME-31 series. Locking on all other models.

Power Consumption: 2.5 Watts on MME-31 series; 3 Watts for all others.

MAXIMUM
Value.
→ Performance.

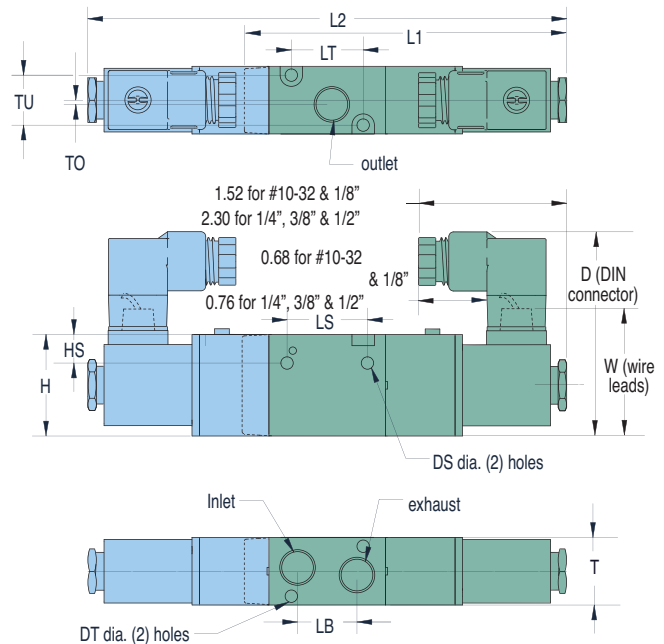

Dim.	MME-31	MME-32	MME-33	MME-34
D	2.14	2.65	2.71	2.94
DS	0.13	0.17	0.17	0.22
DT	0.13	0.13	0.17	0.17
H	1.07	1.38	1.58	1.97
HS	0.30	0.31	0.41	0.53
L1	3.38	4.39	4.70	5.39
L2	5.02	6.49	6.76	7.55
LB	0.63	0.71	0.94	1.42
LS	0.83	0.98	1.18	2.01
LT	0.75	1.30	1.37	1.61
T	0.71	0.87	1.06	1.34
TO	0.06	0.06	0.16	0.16
TU	0.50	0.65	0.80	1.07
W	1.32	1.51	1.54	1.73

Single Solenoid Valves		Double Solenoid Valves		Inlet	Outlet	Exhaust	Cv/scfm*
<u>MME-31NES-</u>		<u>MME-31NEE-</u>		#10-32	#10-32	#10-32	0.58/27
<u>MME-31PES-</u>		<u>MME-31PEE-</u>		1/8" NPT	1/8" NPT	1/8" NPT	0.67/31
<u>MME-32QES-</u>		<u>MME-32QEE-</u>		1/4" NPT	1/4" NPT	1/4" NPT	0.89/49
<u>MME-33WES-</u>		<u>MME-33WEE-</u>		3/8" NPT	3/8" NPT	3/8" NPT	1.68/93
<u>MME-34ZES-</u>		<u>MME-34ZEE-</u>		1/2" NPT	1/2" NPT	1/2" NPT	2.79/171

* scfm based on flow @ 100 psig

Add Electrical Connection and Voltage Choices to the end of each Base Part Number - Example: MME-34ZEE-W024



2-Position Single Solenoid Valves

1/4" & 3/8" NAMUR Style



MME-33WESB-D012



MME-32QESB-D220

Maximatic® 3-way and 4-way single solenoid spring return pool valves are also available in 1/4" NPT actuator mount or 3/8" NAMUR mount.

Medium: Air (40 micron filtration) or Inert Gas

Operating Range: 20 to 125 psig

Electrical Connection: DIN terminal with LED indicator ("-D"), or Grommet with 18" Wire Lead ("-W")

Voltage: 12-volt DC ("-012"), 24-volt DC ("-024"), 24-volt AC ("-24A"), 110-volt AC ("-110"), or 220-volt AC ("-220")

Number of Ports: 3 or 5

Mounting: Actuator (1/4" NPT only) or NAMUR (3/8" NPT only).

Manual Override: Locking

Power Consumption: 3 Watts

NAMUR/Actuator mount available on other 3- and 4-way Electronic and Air Pilot valves—
Call for specifications.

3-Way Solenoid Valves

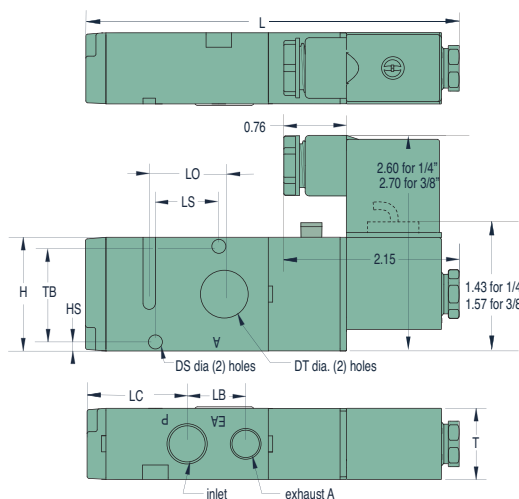

Dim.	1/4" NPT	3/8" NPT
DS	0.17	0.22
DT	0.72	0.78
H	1.38	1.58
HS	0.09	0.15
L	4.49	5.19
LC	1.21	1.57
LB	0.71	0.94
LO	0.9	0.94
LS	0.79	0.94
T	0.86	1.06
TB	1.14	1.26

4-Way Solenoid Valves

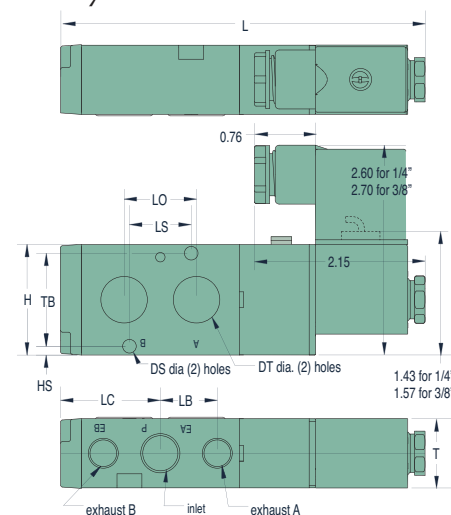

3-Way Single Solenoid Valves

MME-32QESB-
MME-33WESB-



Supply Port

1/4" NPT
3/8" NPT

Outlet

0.72"
0.78"

Exhaust

1/4" NPT
1/4" NPT

Cv/scfm*

0.89/49
1.68/93

4-Way Single Solenoid Valves

MME-42QESB-
MME-43WESB-

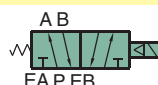

Supply Port

1/4" NPT
3/8" NPT

Outlet

0.72"
0.78"

Exhaust

1/4" NPT
1/4" NPT

Cv/scfm*

0.89/49
1.68/93

* scfm based on flow @ 100 psig

Add Electrical Connection and Voltage Choices to the end of each Base Part Number - Example: **MME-42QESB-D110**



MAXIMATIC® 4-WAY VALVES

2-Position Single & Double Solenoid Valves



Maximatic® 4-way solenoid controlled pilot operated valves are either single solenoid spring return or double solenoid spool valves in #10-32 thread to 1/2" NPT port sizes.

Medium: Air (40 micron filtration) or Inert Gas

Operating Range: 20 to 125 psig

Electrical Connection: DIN connector with LED indicator ("-D"), or 18" Wire Lead ("-W")

Voltage: 12-volt DC ("-012"), 24-volt DC ("-024"), 24-volt AC ("-24A"), 110-volt AC ("-110"), or 220-volt AC ("-220")

Number of Ports: 5

Mounting: Body Ported, Manifold Mount

Manual Override: Non-locking on MME-41 models. Locking on all other models.

Power Consumption: 2.5 Watts on MME-41 models; 3 Watts for all others.

Dim.	MME-41	MME-42	MME-43	MME-44
D	2.14	2.65	2.71	2.94
DS	0.13	0.17	0.17	0.21
DT	0.13	0.13	0.17	0.17
H	1.07	1.38	1.58	1.97
HS	0.16	0.28	0.26	0.29
L1	3.81	4.49	5.19	6.39
L2	5.54	6.49	7.24	8.48
LE	1.09	1.42	1.77	2.48
LO	0.63	0.74	0.96	1.42
LS	0.56	0.98	0.95	1.11
LT	1.18	1.40	1.97	2.82
T	0.71	0.86	1.06	1.34
TU	0.11	0.13	0.16	0.19
TU	0.50	0.65	0.80	1.07
W	1.32	1.51	1.54	1.73

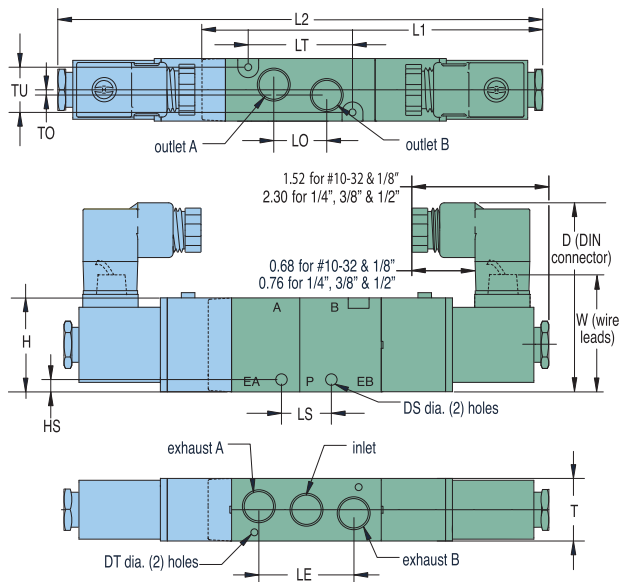

Single Solenoid Valves		Double Solenoid Valves		Inlet	Outlet	Exhaust	Cv/scfm*
MME-41NES-		MME-41NEE-		#10-32	#10-32	#10-32	0.58/27
MME-41PES-		MME-41PEE-		1/8" NPT	1/8" NPT	1/8" NPT	0.67/31
MME-42QES-		MME-42QEE-		1/4" NPT	1/4" NPT	1/8" NPT	0.89/49
MME-43WES-		MME-43WEE-		3/8" NPT	3/8" NPT	1/4" NPT	1.68/93
MME-44ZES-		MME-44ZEE-		1/2" NPT	1/2" NPT	1/2" NPT	2.79/171

* scfm based on flow @ 100 psig

Add Electrical Connection and Voltage Choices to the end of each Base Part Number - Example: **MME-43WEE-D110**

3-Position Spring Centered Double Solenoid Valves



MME-44ZEEC-D024

Maximatic® 4-way double solenoid spring centered valves with closed center, pressure center, pressure center or exhaust center spools are available from #10-32 thread to 1/2" NPT port sizes.

Medium: Air (40 micron filtration) or Inert Gas

Operating Range: 30 to 125 psig on MME-41 series, 20 to 125 psig on all others

Electrical Connection: DIN terminal with LED indicator ("D"), or 18" Wire Lead ("W")

Voltage: 12-volt DC ("-012"), 24-volt DC ("-024"), 24-volt AC ("-24A"), 110-volt AC ("-110"), or 220-volt AC ("-220")

Number of Ports: 5

Mounting: Body Ported, Manifold Mount

Manual Override: Non-locking on MME-41 Series. Locking on all other models.

Power Consumption: 2.5 Watts on MME-41 models; 3 Watts for all others.

Dim.	MME-41	MME-42	MME-43	MME-44
D	2.14	2.65	2.71	2.94
DS	0.13	0.17	0.17	0.21
DT	0.13	0.13	0.17	0.17
H	1.07	1.38	1.58	1.97
HS	0.16	0.28	0.26	0.29
L	6.13	7.24	7.98	8.48
LE	1.09	1.42	1.77	2.48
LO	0.63	0.74	0.96	1.42
LS	0.56	0.98	0.95	1.11
LT	1.18	1.40	1.97	2.82
T	0.71	0.86	1.06	1.34
TO	0.11	0.13	0.16	0.19
TU	0.50	0.65	0.80	1.07
W	1.32	1.51	1.54	1.73

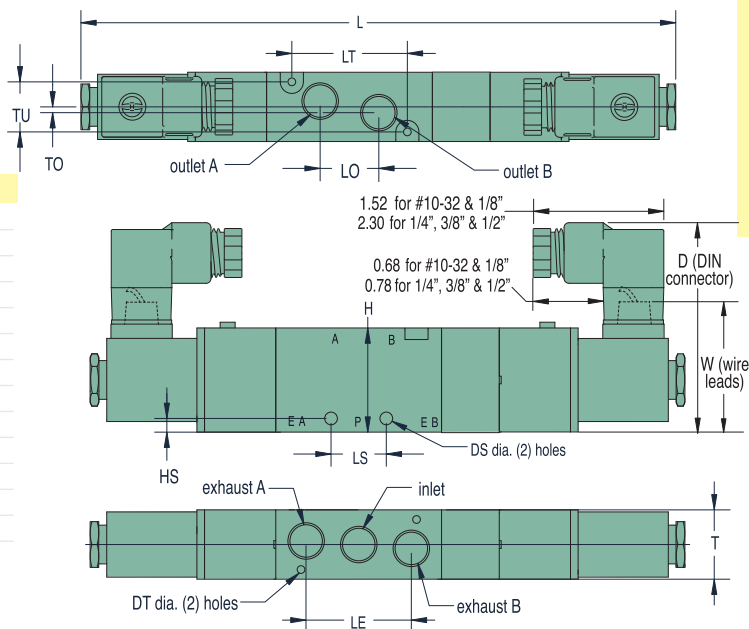

Closed Center	Pressure Center	Exhaust Center	Inlet	Outlet	Exhaust	Cv/scfm*
<u>MME-41NEEC-</u>	<u>MME-41NEEP-</u>	<u>MME-41NEEE-</u>	#10-32	#10-32	#10-32	0.50/23
<u>MME-41PEEC-</u>	<u>MME-41PEEP-</u>	<u>MME-41PEEE-</u>	1/8" NPT	1/8" NPT	1/8" NPT	0.50/23
<u>MME-42QEEC-</u>	<u>MME-42QEEP-</u>	<u>MME-42QEEE-</u>	1/4" NPT	1/4" NPT	1/8" NPT	0.89/49
<u>MME-43WEEC-</u>	<u>MME-43WEEP-</u>	<u>MME-43WEEE-</u>	3/8" NPT	3/8" NPT	1/4" NPT	1.00/72
<u>MME-44ZEEC-</u>	<u>MME-44ZEEP-</u>	<u>MME-44ZEEE-</u>	1/2" NPT	1/2" NPT	1/2" NPT	1.68/93

* scfm based on flow @ 100 psig

Add Electrical Connection and Voltage Choices to the end of each Base Part Number - Example: **MME-41PEEP-W024**



MAXIMATIC® VALVE ACCESSORIES

Rebuild Kits. Convenient rebuild kits are available which contain common maintenance items that may be needed during the life of the valve. Each contains a spool, diamond seal, two pilot seals, two pistons with seals, and spring. Consult factory for 3-position kits.

Part No.	Description
27040-31	3-Way Kit, MME-31
27040-32	3-Way Kit, MME-32
27040-33	3-Way Kit, MME-33
27040-34	3-Way Kit, MME-34
27040-41	4-Way 2 Pos. Kit, MME-41
27040-42	4-Way 2 Pos. Kit, MME-42
27040-43	4-Way 2 Pos. Kit, MME-43
27040-44	4-Way 2 Pos. Kit, MME-44

Parallel Bar Manifolds

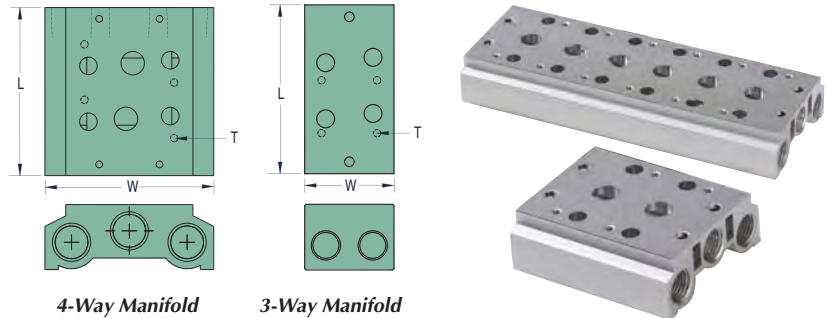

Valve Series	"L" Dimension					"T" Mtg. Thd.
	2-Station	4-Station	6-Station	8-Station	16-Station	
MME-31/41	2.24	3.73	5.25	6.75	12.69	M4
MME-32/42	2.71	4.50	6.33	8.13	15.38	M4
MME-33/43	3.22	5.42	7.62	9.82	18.63	M5
MME-34/44	3.85	6.56	9.38	12.10	23.11	M5

Parallel circuit manifold bars are available for all sizes of MME 3- and 4-way valves. Manifolds are made in increments of two stations from 2 to 16, and are supplied with mounting screws and gaskets. Spare kits are also available which include two screws and a gasket. Blank plate supplied with one gasket, two screws and metal plate.

Valve Series	Manifold Inlet/						
	Exhaust	Blank Plate	2-Station	4-Station	6-Station	8-Station	16-Station
3-Way Valve Manifolds							
MME-31	1/8"	MMM-31-B	MMM-31-02	MMM-31-04	MMM-31-06	MMM-31-08	MMM-31-16
MME-32	1/4"	MMM-32-B	MMM-32-02	MMM-32-04	MMM-32-06	MMM-32-08	MMM-32-16
MME-33	3/8"	MMM-33-B	MMM-33-02	MMM-33-04	MMM-33-06	MMM-33-08	MMM-33-16
MME-34	1/2"	MMM-34-B	MMM-34-02	MMM-34-04	MMM-34-06	MMM-34-08	MMM-34-16

3-Way Spare Mounting Kit Hardware

27041-31	Hardware Kit for MME-31 Series Valves	27041-33	Hardware Kit for MME-33 Series Valves
27041-32	Hardware Kit for MME-32 Series Valves	27041-34	Hardware Kit for MME-34 Series Valves

Valve Series	Manifold Inlet/						
	Exhaust	Blank Plate	2-Station	4-Station	6-Station	8-Station	16-Station
4-Way Valve Manifolds							
MME-41	1/4"	MMM-41-B	MMM-41-02	MMM-41-04	MMM-41-06	MMM-41-08	MMM-41-16
MME-42	1/4"	MMM-42-B	MMM-42-02	MMM-42-04	MMM-42-06	MMM-42-08	MMM-42-16
MME-43	3/8"	MMM-43-B	MMM-43-02	MMM-43-04	MMM-43-06	MMM-43-08	MMM-43-16
MME-44	1/2"	MMM-44-B	MMM-44-02	MMM-44-04	MMM-44-06	MMM-44-08	MMM-44-16

4-Way Spare Mounting Kit Hardware

27041-41	Hardware Kit for MME-41 Series Valves	27041-43	Hardware Kit for MME-43 Series Valves
27041-42	Hardware Kit for MME-42 Series Valves	27041-44	Hardware Kit for MME-44 Series Valves



Replacement Coils



Industrial Form
2.5 Watt
#10-32 & 1/8"

Form B
3.0 Watt
1/4", 3/8" & 1/2"

Form B
6.5 Watt
Direct-Acting

Replacement coils for solenoid valves are available in voltages from 12 VDC to 220 VAC with either DIN connector or 18" wire leads. Refer to DIN Connectors below.

Description	2.5 Watt #10-32 & 1/8"	3.0 Watt 1/4", 3/8" & 1/2"	6.5 Watt Direct-Acting
DIN Connectors			
12-Volt VDC	27001-D012	27065-D012	27002-D012
24-Volt VDC	27001-D024	27065-D024	27002-D024
110-Volt VAC	27001-D110	27065-D110	27002-D110
220-Volt VAC	27001-D220	27065-D220	27002-D220
24-Volt VAC	27001-D24A	27065-D24A	27002-D24A
Wire Leads			
12-Volt VDC	27001-W012	27065-W012	27002-W012
24-Volt VDC	27001-W024	27065-W024	27002-W024
110-Volt VAC	27001-W110	27065-W110	27002-W110
220-Volt VAC	27001-W220	27065-W220	27002-W220
24-Volt VAC	27001-W24A	27065-W24A	27002-W24A

DIN Connectors

DIN 43650 Form B Connectors with 11 mm spade center spacing. DIN type size 2, 3 and 4 Maximatic valves. Industrial Form Connectors with 9.4 mm spade center spacing are designed to connect to 15 mm terminal coils. Both are available with or without surge suppression, and 152 or 381 mm PVC molded three-wire cord set.



Form B Part No.	Industrial Form Part No.	Volts	LED	Cord
CC-B	CC-I			-
CC-B-P6	CC-I-P6	6-240	no	6'
CC-B-P15	CC-I-P15			15'
CC-BLL	CC-ILL			-
CC-BLL-P6	CC-ILL-P6	6-24	yes	6'
CC-BLL-P15	CC-ILL-P15			15'
CC-BLM	CC-ILM			-
CC-BLM-P6	CC-ILM-P6	48-110	yes	6'
CC-BLM-P15	CC-ILM-P15			15'
CC-BLH				-
CC-BLH-P6		208-240	yes	6'
CC-BLH-P15				15'

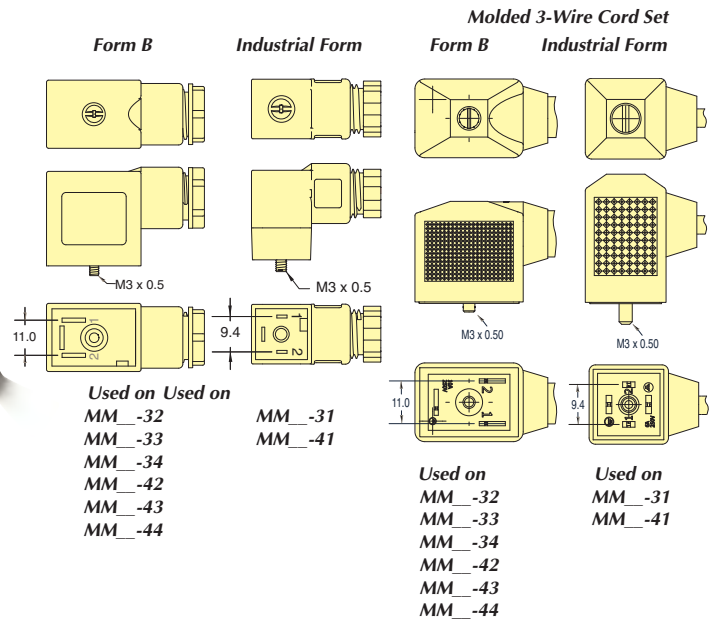

Used on
MM_-32
MM_-33
MM_-34
MM_-42
MM_-43
MM_-44

MM_-31
MM_-41

Used on
MM_-32
MM_-33
MM_-34
MM_-42
MM_-43
MM_-44

Used on
MM_-31
MM_-41

Sub-Assemblies & Kits

Call Clippard to inquire more about our Value Added services.



Metric line available. Visit www.clippard.com



Exhaust Mufflers

For quiet system operation, see page [326](#) for effective exhaust mufflers.



Speed Control Mufflers

For quiet system operation with speed control, see page 154.



Push-Quick Fittings

See pages 304 through 312 for a complete selection of easy-to-install Push-Quick Fittings.